



ErisTerminal® SIP Deskset

VSP725

**User Guide**





# Congratulations

on your purchase of this VTech product. Before using this product, please read **Important Safety Information** on page 4 of this manual. Please thoroughly read this user's manual for all the feature operations and troubleshooting information necessary to install and operate your product. You can also visit our website at **[businessphones.vtech.com](http://businessphones.vtech.com)** or call **1 (888) 370-2006**.

Please note the serial number of your product, which can be found on the back of the deskset. Save your sales receipt and original packaging in case it is necessary to return your telephone for warranty service.

# Important Safety Information



This symbol is to alert you to important operating or servicing instructions that may appear in this user's manual. Always follow basic safety precautions when using this product to reduce the risk of injury, fire, or electric shock.

## Important safety instructions

---

When using your telephone equipment, basic safety precautions should always be followed to reduce the risk of fire, electric shock and injury, including the following:

1. This product should be installed by a qualified technician.
2. This product should only be connected to the host equipment and never directly to the network such as Public Switch Telephone Network (PSTN) or Plain Old Telephone Services (POTS).
3. Read and understand all instructions.
4. Follow all warnings and instructions marked on the product.
5. Unplug this product from the wall outlet before cleaning. Do not use liquid or aerosol cleaners. Use a damp cloth for cleaning.
6. Do not use this product near water such as near a bath tub, wash bowl, kitchen sink, laundry tub or swimming pool, or in a wet basement or shower.
7. Do not place this product on an unstable table, shelf, stand or other unstable surfaces.
8. Slots and openings in the back or bottom of the telephone base and handset are provided for ventilation. To protect them from overheating, these openings must not be blocked by placing the product on a soft surface such as a bed, sofa or rug. This product should never be placed near or over a radiator or heat register. This product should not be placed in any area where proper ventilation is not provided.
9. This product should be operated only from the type of power source indicated on the marking label. If you are not sure of the type of power supplied at the premises, consult your dealer or local power company.
10. Do not allow anything to rest on the power cord. Do not install this product where the cord may be walked on.
11. Never push objects of any kind into this product through the slots in the telephone base or handset because they may touch dangerous voltage points or create a short circuit. Never spill liquid of any kind on the product.

12. To reduce the risk of electric shock, do not disassemble this product, but take it to an authorized service facility. Opening or removing parts of the telephone base or handset other than specified access doors may expose you to dangerous voltages or other risks. Incorrect reassembling can cause electric shock when the product is subsequently used.
13. Do not overload wall outlets and extension cords.
14. Unplug this product from the wall outlet and refer servicing to an authorized service facility under the following conditions:
  - A. When the power supply cord or plug is damaged or frayed.
  - B. If liquid has been spilled onto the product.
  - C. If the product has been exposed to rain or water.
  - D. If the product does not operate normally by following the operating instructions. Adjust only those controls that are covered by the operation instructions. Improper adjustment of other controls may result in damage and often requires extensive work by an authorized technician to restore the product to normal operation.
  - E. If the product has been dropped and the telephone base and/or handset has been damaged.
  - F. If the product exhibits a distinct change in performance.
15. Avoid using a telephone (other than cordless) during an electrical storm. There is a remote risk of electric shock from lightning.
16. Do not use the telephone to report a gas leak in the vicinity of the leak. Under certain circumstances, a spark may be created when the adapter is plugged into the power outlet, or when the handset is replaced in its cradle. This is a common event associated with the closing of any electrical circuit. The user should not plug the phone into a power outlet, and should not put a charged handset into the cradle, if the phone is located in an environment containing concentrations of flammable or flame-supporting gases, unless there is adequate ventilation. A spark in such an environment could create a fire or explosion. Such environments might include: medical use of oxygen without adequate ventilation; industrial gases (cleaning solvents; gasoline vapors; etc.); a leak of natural gas; etc.
17. Only put the handset of your telephone next to your ear when it is in normal talk mode.
18. The power adapters are intended to be correctly oriented in a vertical or floor mount position. The prongs are not designed to hold the plug in place if it is plugged into a ceiling, under-the-table or cabinet outlet.
19. Use only the power cord indicated in this manual.

20. For pluggable equipment, the socket-outlet shall be installed near the equipment and shall be easily accessible.
21. In wall mounting position, make sure to mount the telephone base on the wall by aligning the eyelets with the mounting studs of the wall plate. Then slide the telephone base down on both mounting studs until it locks into place. Refer to the full instructions in **Deskset Installation** in this user guide.
22. CAUTION: Keep small metallic objects such as pins and staples away from the handset receiver.

## **SAVE THESE INSTRUCTIONS**

# ErisTerminal SIP Deskset

## VSP725

### User Guide

## Table of Contents

### Important Safety Information

Important safety instructions..... 4

### Introduction

Deskset features..... 9

### Quick Reference Guide

Front panel features ..... 10

Dial pad and audio keys ..... 11

Programmable keys..... 11

### Deskset Installation

Overview..... 13

Network requirements ..... 13

Location ..... 14

Rear panel features ..... 15

Connecting the phone ..... 15

### Using the Phone

Idle screen ..... 18

Idle mode screen icons..... 18

Active call screen icons ..... 18

Programmable feature key lights..... 19

Using the menu ..... 19

Main menu items ..... 20

Making calls..... 20

Answering calls..... 22

Putting a call on hold ..... 23

Forwarding calls ..... 24

Transferring calls ..... 26

Making a conference call..... 28

Retrieving messages ..... 30

Using a shared line..... 31

Call monitoring..... 31

Putting a shared-line call on hold .... 31

“Barging in” ..... 32

Busy lamp field ..... 33

Paging ..... 34

Automatic Call Distribution ..... 34

### Phone Features

Using the Features menu ..... 35

Navigating menus..... 35

Using the Call menu ..... 36

Using the local directory ..... 40

Blacklist ..... 43

Call history..... 43

### Speed Dial

Entering speed dial numbers..... 46

### Cordless Headset

Registering an optional cordless headset..... 47

Deregistering a cordless headset.... 48

Deregistering the cordless headset without the deskset.....	48	Call Settings .....	60
Cordless accessory registration and deregistration time-out.....	48	User Preferences.....	62
<b>Cordless Handset</b>		Programmable Keys .....	64
Registering an optional cordless handset.....	49	Directory .....	67
Deregistering the cordless handset.	50	Speed Dial .....	70
<b>Status</b>		<b>Troubleshooting</b>	
Finding the firmware version .....	51	General issues.....	71
<b>Configuring the Phone</b>		<b>Specifications</b>	
Using the User Settings menu.....	52	Electrical and environmental specifications.....	72
Preferences .....	53	<b>Soft Keys</b>	
Setting the language.....	53	Index of soft keys.....	73
Setting the date and time.....	53	<b>Special Characters</b>	
Display.....	55	Entering special characters .....	74
Audio .....	56	<b>Maintenance</b>	
Configuring the programmable keys	57	Taking care of your telephone .....	75
<b>WebUI</b>		<b>GPL License Information</b>	
Using the WebUI .....	58	GPL code requests.....	76
Status .....	59		



# Introduction

This user's manual contains detailed instructions for using your VSP725 deskset. Please read this user's manual before using your telephone.

## Deskset features

---

The VTech VSP725 deskset is full-featured SIP endpoint business phone designed to work with popular hosted IP PBX services and on-premise SIP PBXs. Once you have ordered and configured your PBX service, the deskset enables you to make and receive calls as you would with any other business phone. The deskset provides calling features such as hold, transfer, conferencing, speakerphone, quick-dial numbers and one-touch voicemail access.

There are two ports, known as the Ethernet port and PC port, at the back of the deskset. The Ethernet port allows the VSP725 deskset to connect to the hosted IP PBX via a router. The PC port is for another device such as a personal computer to connect to the local area network through the deskset.

The VSP725 deskset supports paging and call transfers between system extensions and can connect you and two other parties on the same conference call.

The telephone also has 12 dual-function programmable keys. You or your system administrator can program these keys for functions such as quick dial, redial, Do Not Disturb, call forwarding, message retrieval, and call parking.

The keys can also be programmed to monitor other desksets in the system. You can press the key for a monitored extension to answer a call at your own deskset. The programmable keys have two-color LEDs to indicate call activity. For more information about the programmable keys, see page 11.

The VSP725 IP Phone Features include:

- Backlit Liquid Crystal Display
- Speakerphone, Hold and Mute
- Up to 3 lines
- Up to 6 active calls
- 3-way conferencing
- 12 dual-function programmable keys
- Message Waiting alert LED
- Dual 10/100 Mbps Ethernet ports
- Power over Ethernet enabled
- DECT cordless headset and corded headset support
- 200-entry local directory

# Quick Reference Guide

## Front panel features

### MESSAGE WAITING indicator

Illuminates when you have a new voice message.

### Programmable keys

Can be programmed to perform various functions or access various features.

For example:

- Press to access a line to make a call.
- Press to dial a monitored extension or a quick-dial number.
- Press to turn a feature such as Do Not Disturb on and off.

### Key label card

To write on the key label card, pull out the card from under the plastic cover.

### LOWER

Press to access the second level (alternate function) of a programmable key.

### Corded headset input (on side)



### SPEAKER

Press to turn the speakerphone on or off

### MIC

### SCREEN

Displays call information, soft key labels, and deskset menus.

### CANCEL

While in a menu, press to cancel an operation and exit the menu.

### MENU

Press to display the deskset menu.



### SOFT KEYS

Perform different actions depending on the on-screen labels.

### SELECT

Press to select a menu item.

### HOLD

Press to put a call on hold.

### NAVIGATION KEY

While in menus, press ▼ or ▲ to scroll through the menu, highlight items or change settings. While entering names, numbers or other text, press ◀ or ▶ to move the cursor left or right.

# Quick Reference Guide

## Dial pad and audio keys

### Dial pad

Use to dial numbers and enter text. For a list of special characters you can enter with the dial pad, see page 74.

### MUTE

During a call, press to prevent your voice from being heard.

### VOLUME

- During a call, press to adjust the listening volume.
- During message playback, press to adjust the playback volume.
- When the phone is idle, press to adjust the ringer volume.



### HEADSET

When a headset is connected to the deskset, press to make, answer, or hang up a call.

## Programmable keys

The table below lists the default settings for the programmable keys. The key assignments on your phone may be different. Some keys may be programmed as Quick Dial keys, for example. Ask your system administrator about your phone's programmable key configuration.

Key Number	Setting
1	Line 1*
2	Line 1
3	Line 1
4	Directory
5	Call History
6	Redial
7	Messages
8	Do Not Disturb
9	Call Forward All
10	None
11	None
12	None
13–24	None

\* Your system administrator can assign more than one key to a line. For example, you might be able to activate Line 1 with keys 1 and 2, and Line 2 with keys 3 and 4. Consult your administrator regarding your phone's line configuration.

# Quick Reference Guide

## Other possible programmable key settings

- Quick Dial
- BLF—Busy lamp field keys let you monitor activity at other phones. The key LED indicates call status. See “Programmable feature key lights” on page 19.
- ACD—If you are subscribed to this feature, pressing the Automatic Call Distribution (ACD) key displays the ACD state menu.
- Call Forward Busy
- Call Forward No Answer
- Page—If this feature is enabled, press the Page key to call one or a group of phones. Your system administrator can configure a page to be automatically answered.
- Multicast Page —this feature allows you to call up to ten paging zones.
- Park Call—Dials the access code to park your current call.
- Retrieve Parked Call—Dials the access code to retrieve a parked call.
- In Call DTMF—Dials a string of numbers while you are on a call. For example, pressing the key might dial a conference access code.
- Call Return—Dials the number of the last missed call.
- Group Call Pickup—Dials the Group Call Pickup code, allowing you to answer a call ringing at another extension.
- Direct Call Pickup—Dials the Direct Call Pickup code, allowing you to answer a call ringing at a specific extension. After pressing the button, you may need to enter the extension number manually.

# Deskset Installation

## Overview

---

This section assumes that your network infrastructure is established and that your IP PBX service has been ordered and configured for your location.

Install the phone close to a router or network switch. You can power the phone using the supplied power adapter or Power over Ethernet (PoE—Class 2). If you are not using PoE, install the phone near a power outlet not controlled by a wall switch. The phone can be placed on a flat surface or vertically mounted on the wall.

For customer service or product information, visit our website at **[businessphones.vtech.com](http://businessphones.vtech.com)** or call **1 (888) 370-2006**.

## Network requirements

---

A switched network topology is recommended for your LAN (using standard 10/100 Ethernet switches that carry traffic at a nominal rate of 100 Mbit/s).

The office LAN infrastructure should use Cat.-5/Cat.-5e cable.

The LAN connections to the deskset(s) should all be wired. However, wireless connections to other devices (such as laptops) in your office will not impede performance.

All desksets must reside on a single subnet. A Dynamic Host Configuration Protocol (DHCP) server is recommended and must be on the same subnet as the desksets so that IP addresses can be auto-assigned. In most cases, your network router will have a DHCP server. By default, the deskset has DHCP enabled for automatic IP address assignment.

**Note:** Some DHCP servers have default settings that limit the number of network IP addresses assigned to devices on the network. You should log in to your server to confirm that the IP range is sufficient.

If no DHCP server is present, you can assign static IPs to desksets. You can assign a static IP address using the deskset menus. Go to Admin settings > Network setting > Set static IP. See the Administrator and Provisioning Guide for more information. If you do not have a DHCP server or do not manually assign static IPs, you will not be able to access the WebUI and/or enable automatic time updates from an NTP server.

A DNS server is recommended to resolve the path to the Internet and to a server for firmware and configuration updates. If necessary, the system administrator can also download upgrade files and use the WebUI to update the deskset firmware and/or configuration settings manually.

For users whose computers require a GigE Ethernet frame rate (a gigabit per second), use separate Ethernet connections for the deskset and the computer. The Ethernet connection through a deskset is limited to 100 Mbits/s.

## Location

---

Avoid placing the deskset too close to:

- Communication devices such as television sets, DVD players, or other cordless telephones
- Excessive heat sources
- Noise sources such as a window with traffic outside, motors, microwave ovens, refrigerators, or fluorescent lighting
- Excessive dust sources such as a workshop or garage
- Excessive moisture
- Extremely low temperature
- Mechanical vibration or shock such as on top of a washing machine or work bench

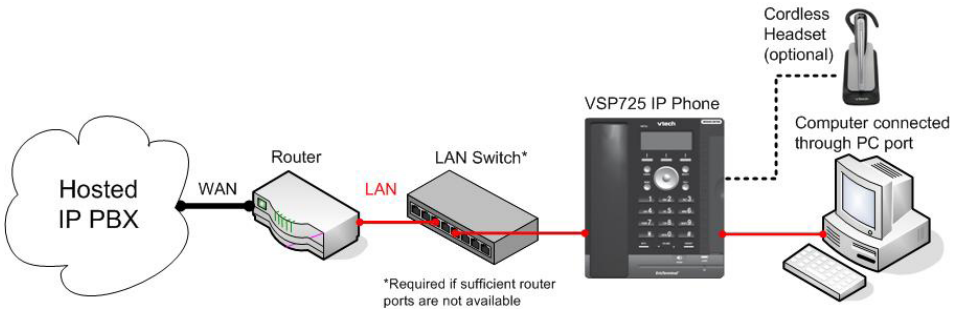

# Deskset Installation

## Rear panel features

---

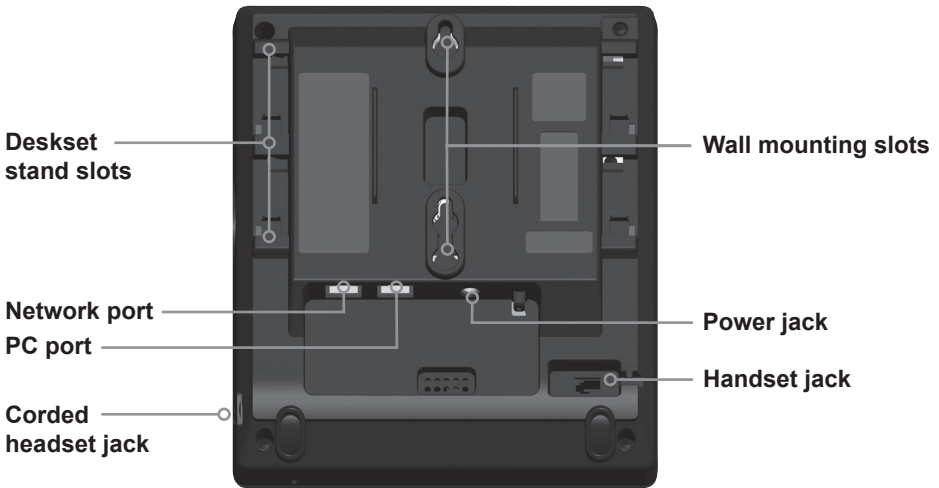

## Connecting the phone

---

### IMPORTANT INFORMATION

1. Use only a compatible VTech power adapter.  
To order a replacement power adapter, visit our website at **businessphones.vtech.com**, or call **1 (888) 370-2006**.
2. The power adapter is intended to be correctly oriented in a vertical or floor mount position. The prongs are not designed to hold the plug in place if it is plugged into a ceiling, under-the-table or cabinet outlet.

### To install the phone:

1. If you plan to place the phone on a flat surface, attach the stand. Line up the tabs on the stand with the slots on the rear of the phone. Two sets of slots allow you to attach the stand at either a 45-degree or 35-degree angle.
2. Plug the end of the coiled handset cord into the Handset jack on the rear of the phone. Secure the cord by routing it through the slot and underneath the tab.



3. Plug one end of the Ethernet cable into the Ethernet port on the rear of the deskset (marked by ) , and plug the other end of the cable into your network router or switch.

**Note:** You may need to use a network switch connected to your router if your router does not have sufficient ports for the number of phones you want to install. If you use a network switch, connect the phone to the switch instead of the router in the previous step.

4. If the deskset is not using power from a PoE-capable network router or switch:
  - a. Connect a power adapter to the deskset power jack.
  - b. Plug the power adapter into an electrical outlet not controlled by a wall switch.

If there is a networked computer and no extra Ethernet wall jacks near the phone, then the phone and PC can share the same network connection.

### To share a network connection with a PC:

1. Plug a Cat.-5 Ethernet cable into the PC port on the phone (marked by ).
  2. Plug the other end of the Cat.-5 Ethernet cable into your computer's Ethernet port.
- If a GigE network is being used, a computer connected through the phone will be limited to 100 Mbits/s. If you require a GigE Ethernet rate, use separate Ethernet connections for the phone and the computer.
  - If a PC is connected to your network through a phone, any phone resets and power or network interruptions will disrupt the PC's connection to the network.

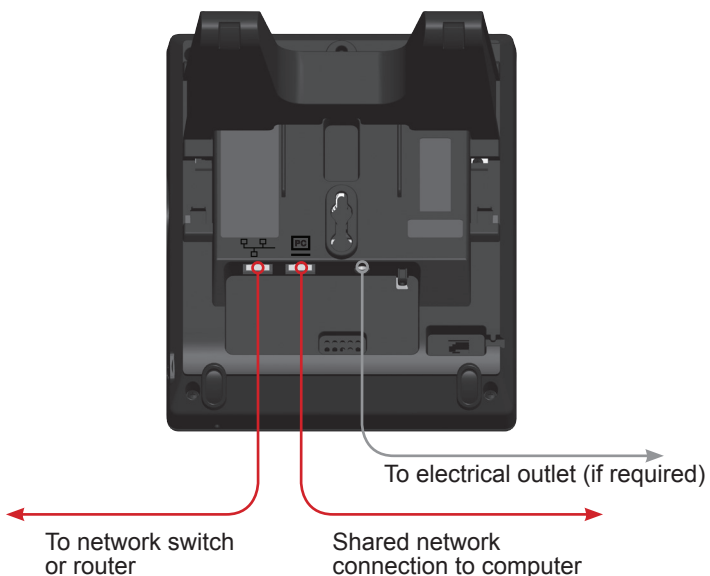



# Deskset Installation

## To mount the phone on the wall:

1. Prepare the wall-mount screws. The deskset will fit onto wall-mount screws with centers  $3 \frac{1}{4}$  inches (8.2 cm) or 4 inches (10.2 cm) apart. Most standard wall plates have screw centers  $3 \frac{1}{4}$  inches (8.2 cm) apart.
2. Put the corded handset aside. Use a screwdriver or coin to rotate the handset tab 180 degrees. The protruding edge of the tab holds the corded handset when the phone is mounted on the wall.

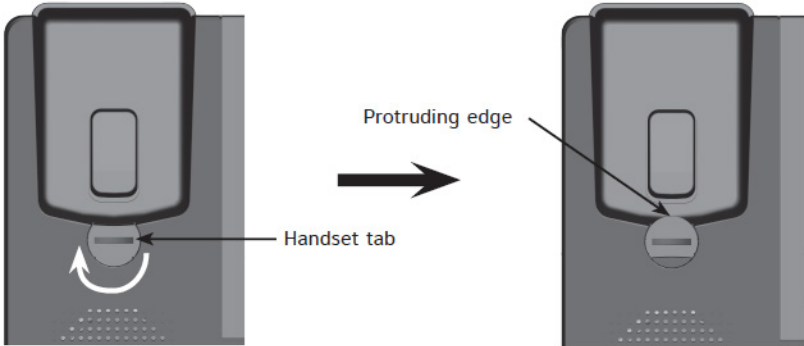

3. Connect the network cable(s) and, if required, the power adapter.
4. Place the deskset base over the mounting screws. Align the upper wall mounting hole on the back of the phone with the upper mounting screw. Make sure the lower wall mounting hole on the phone also aligns with the lower mounting screw.
5. Slide the deskset base down over the mounting screws.
6. Bundle the network cable(s) and power adapter cord (if using the power adapter) neatly with twist ties.

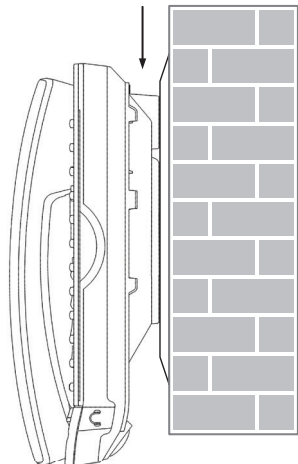
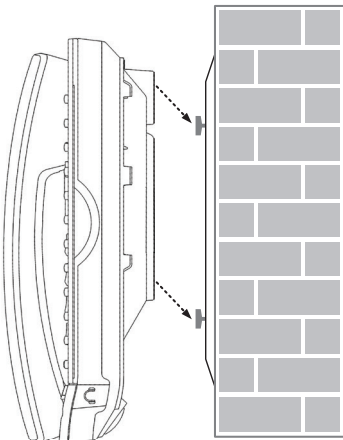

# Using the Phone

## Idle screen

The Idle screen appears after the phone is connected and configured for your SIP PBX service. The Idle screen indicates that you have no active or held calls.

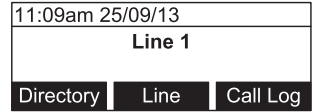





From the Idle screen, you can press:

- **Directory** to view the directories that are available to you. See “Using the local directory” on page 40.
- **Line** to select another line (SIP Account). When you make a call, the phone will use this line. See “Making calls” on page 20. **Note:** **Line** appears only if more than one SIP account is registered to your phone.
- **Call Log** to view the phone’s call history. See “Call history” on page 43.

Note that the default Idle screen soft keys are shown above. Your phone’s soft keys are programmable and may differ from what is shown here.





## Idle mode screen icons

In idle mode, the following screen icons indicate your phone’s current settings.

Icon	Status
	Call Forward All is on. See “To set Call forward:” on page 37.
	The ringer is off.
	Do Not Disturb is on. See “To set Do Not Disturb:” on page 37.
	The Ethernet cable is unplugged or the network is down.

## Active call screen icons

During a call, the following screen icons indicate the call’s status.

Icon	Status
	Headset—audio is coming through a headset after the <b>HEADSET</b> key was pressed.
	The call is being handled by the Cordless Handset (optional accessory).
	Speakerphone—the speakerphone is active.
<b>1/2</b>	Call counter—more than one call is active.
	More than one call is active. Press ▼ or ▲ to view another call.

# Using the Phone

## Programmable feature key lights

The programmable feature key lights indicate call status and other information, depending on how the key is configured.

Key	Light Activity	Description
Line	Flashing ORANGE	Line is unregistered
	Solid GREEN	On a call or dialing
	Quickly flashing GREEN	Ringing incoming call
	Slowly flashing GREEN	Held call
	Steady ORANGE	Cordless Handset in use
Shared line key	Steady ORANGE	The shared line is on a call
	Slowly flashing ORANGE	The shared line is on hold
Do not disturb	Off	DND is off
	Steady ORANGE	DND is on
Call forward	Off	Call forward is off
	Steady ORANGE	Call forward is on
Busy lamp field	Off	Monitored phone is idle
	Steady ORANGE	Monitored phone is on a call or has a held call
	Quickly flashing ORANGE	The monitored phone is ringing
	Flashing ORANGE	Registration error.
Automatic Call Distribution	Quickly flashing GREEN	ACD agent "wrap up" state
	Steady GREEN	ACD agent ready state
	Slow Flash GREEN	ACD agent unavailable state
	Steady ORANGE	ACD logged on
	Slowly flashing ORANGE	ACD logged off
	Quickly flashing ORANGE	ACD subscription error

## Using the menu

1. Press **MENU** to show the main menu.
2. Press ▼ or ▲ to highlight menu items.
3. Press **SELECT** or a corresponding dial pad key to select a highlighted menu item. For example, when Features is highlighted, you can press **SELECT** or you can press **1** on the dial pad to view the Features submenu.
4. Press **SELECT** or an appropriate soft key to save changes.
5. Press **CANCEL** to stop an operation, exit a menu or return to the idle screen.

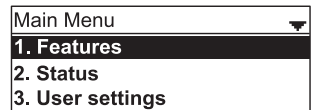

# Using the Phone

## Main menu items

---

1. Features (see page 35)
2. Status (see page 51)
3. User Settings (see page 52)
4. Admin Settings (available only to your system administrator)

## Making calls

---

You can make a call at any time by choosing an off-hook method (such as lifting the handset, pressing a Line key, or pressing **HEADSET** or **SPEAKER**), and then dialing a number. When the phone is in idle mode or has calls on hold, you can make a call by pre-dialing a phone number and then going off hook to call the number.

### To go off hook and make a call:

1. To use the default line, lift the handset, press **HEADSET**, or press **SPEAKER**. To use a specific line, press a Line key. You hear a dial tone.
2. Use the key pad to enter the desired phone number.

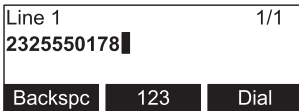

- Press **Backspc** if you enter an incorrect digit.
  - Press **123** to change from entering digits to entering letters (if you need to enter a domain name as part of the number).
3. Press **Dial**, or, if the phone accepts the number as valid, it dials the number after a short delay.

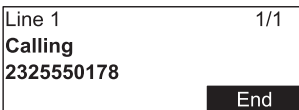

Note that the default live dial soft keys are shown above. Your phone's soft keys are programmable and may differ from what is shown here.

If Hotline is enabled, then the phone will automatically dial a pre-programmed number after going off hook.

# Using the Phone

## Making calls (continued)

---

### To make a call by pre-dialing:

1. Use the key pad to enter the desired phone number.



- Press **Backspc** if you enter an incorrect digit.
  - Press **123** to change from entering digits to entering letters (if you need to enter a domain name as part of the number).
2. Dial the number by:
    - Pressing **Dial**. The phone will use the preferred audio mode (speaker or headset) until you lift the handset.
    - Lifting the handset.
    - Pressing the desired Line key.
    - Pressing **SPEAKER** or **HEADSET**.

When the call is answered, the active call screen appears.



To end the call, hang up or press **End**. If you are on speakerphone and the handset is “on hook,” press **SPEAKER** to end your call.

Note that the default active call screen soft keys are shown above. Your phone’s soft keys are programmable and may differ from what is shown here.

### To make a call using quick dial:

- Press the desired quick dial programmable key.

—or—

Press and hold a dial pad key that matches the number of the desired speed dial entry. For example, to dial speed dial entry 4, press and hold 4 on the dial pad. See “Speed Dial” on page 46.

# Using the Phone

## Answering calls

---

### To answer a call:

- Lift the handset, or press **Answer**, **SPEAKER**, or **HEADSET**.



You can also press a flashing green Line key to answer that incoming call.

If you have multiple incoming calls, (as indicated by ) , press ▼ or ▲ to select the call you want to answer.



On the incoming call screen, you can also press:

- **Reject** to terminate the incoming call.
- **Forward** to forward the call to another number.

If you don't respond to an incoming call, the phone displays a missed-call alert screen.

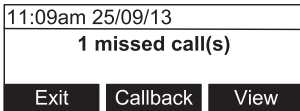

If a missed call alert screen appears, you can press:

- **Exit** to return to the Idle screen.
- **Callback** to immediately dial the caller's number.
- **View** to see the caller's information in the call history.

# Using the Phone

## Putting a call on hold

---

Use this feature to hold one call while you access another. The deskset also puts calls on hold automatically when you answer another call, transfer a call, or create a conference.

See also, “Putting a shared-line call on hold” on page 31.

### To put a call on hold:

- During a call, press **HOLD** on the deskset.

The On hold screen appears. The programmable key for that line flashes green slowly.

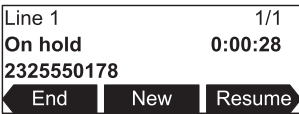

From the On hold screen, you can press:

- **End** to end the call
- **New** to dial a new call
- **Resume** to take the call off hold.
- **Transfer** to transfer the held call to another party.
- **Conf** to start a conference with the held call.

Note that the default On hold screen soft keys are shown above. Your phone's soft keys are programmable and may differ from what is shown here.

If another party puts you on hold, you may see the message **Held by far end**. This message depends on compatibility between phones and PBX types, and may not always appear. You can press **End** to end the call.

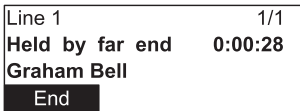

# Using the Phone

## Forwarding calls

---

You can forward an incoming call to another number, either by entering the number yourself, or by selecting a number from the directory, redial list, or call history.

**Note:** Your deskset Call Forward–No Answer setting will cancel the manual forwarding process if it takes effect first. For example, your deskset may be set to forward calls to voicemail after a call rings for 10 seconds, before you can reach the deskset to forward the call yourself. If you have problems forwarding calls because of the Call Forward–No Answer setting, ask your system administrator to extend your Call Forward–No Answer delay.

See also “Using the Call menu” on page 36.

### To forward a call using manual entry:

1. When an incoming call appears, press **Forward** .  
The deskset stops ringing and the **Forward to** screen appears.



Line 1  
Forward to:  
█  
Cancel 123

If you press **Cancel** , the deskset begins ringing again and the incoming call screen reappears.

2. Enter the number to which you want to forward the call.



Line 1  
Forward to:  
2325551234 █  
Backspc 123 Forward

3. Press **Forward** . Your phone returns to idle mode if you have no other active calls.



# Using the Phone

## Forwarding calls (continued)

---

### To forward a call using the directory, redial list, or call history:

1. When an incoming call appears, press **Forward** .  
The deskset stops ringing and the **Forward to** screen appears.



2. Press a programmable key (if available) to display the directory, redial list, or call history. You can also navigate to the call history or directory using the deskset Features menu.

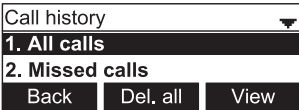

Select the call history folder or directory you want to access.

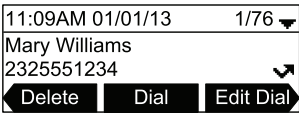

3. If necessary, press ◀ or ▶ until **Dial** appears and then press **Dial** to forward the call to the number. Your phone returns to idle mode if you have no other active calls.

# Using the Phone

## Transferring calls

---

You can transfer a call to someone else at another phone.

If you talk to the transfer recipient before completing the transfer, you are making a “supervised” transfer.

However, the transfer recipient does not have to talk to you before receiving the transferred call. If you do not talk to the transfer recipient before transferring the call, you are making a “blind” transfer.

You can also transfer a call to a held call.

### To transfer a call (supervised):

1. During a call, press **Transfer**. The call is automatically put on hold and the transfer setup screen appears.

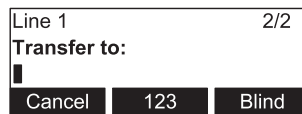

2. Dial the number to which you want to transfer the call. You can also use a number from a list, such as the Directory or Call History.
3. When the second caller answers, you can talk to the caller to notify them of the transfer, then press **Transf** to transfer the call.

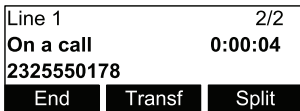

The **Call transferred** screen appears, and your phone returns to idle mode.

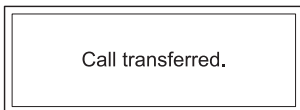

### To cancel the transfer, press:

- **Cancel** on the transfer setup screen. The active call screen reappears.
- **End** when the second call is active. You will hang up on the second call.
- **Split** when the second call is active. You will stay connected to the second call. Your first call remains on hold.

# Using the Phone

## Transferring calls (continued)

---

### To transfer a call (blind):

1. During a call, press **Transfer**. The call is automatically put on hold and the transfer setup screen appears.



2. Press **Blind**.
3. Dial the number to which you want to transfer the call. You can also use a number from a list, such as the Directory or Call History.
4. Press **Transf**, or wait for the phone to automatically dial, once it recognizes a valid number.

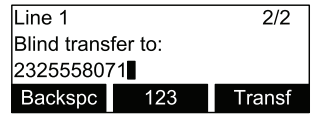

The **Call transferred** screen appears, and your phone returns to idle mode.

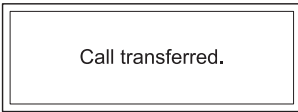

If the blind transfer fails, then the transferred call will ring your phone back.

### To transfer a call to a held call:

1. During a call, press ◀ or ▶ to view the next set of soft keys.
2. Press **XferCall**. The call is automatically put on hold, and a list of held calls

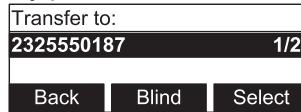

appears.

3. On the Transfer to target screen, press:
  - **Select** to talk to the held call, then press **Transf** to transfer the first call.
  - **Blind**, then **Select** to transfer the first call to the held call immediately.

The **Call transferred** screen appears, and your phone returns to idle mode.



# Using the Phone

## Making a conference call

---

You can hold a conference call between yourself and two other callers.

### To make a conference call:

1. During a call, press **Conf**. The call is automatically put on hold and the conference setup screen appears.

Line 1	1/1
On a call	0:00:28
2325550178	
End	Transfer Conf



Line 1	2/2
Conference with:	
Cancel	123

2. Dial the second number for the other party you want to join your conference. You can also use a number from a list, such as the Directory or Call History.
3. When the second call is established, press **Conf**. The conference begins and the conference screen appears.

Line 1	2/2
On a call	0:00:04
2325557018	
End	Conf Split



Line 1	
Conference	0:01:08
End	Split Bridge

### To cancel the conference setup, press:

- **Cancel** on the conference setup screen. The active call screen reappears.
- **End** when the second call is established. You will hang up on the second call and return to your first call.
- **Split** when the second call is established. You will remain on the second call and your first call remains on hold.

# Using the Phone

## Making a conference call (continued)

When you have an active call and a held call, you can also create a conference with the held call.

### To create a conference with a held call:

1. During a call, press ◀ or ▶ to view the next set of soft keys.
2. Press **ConfCall**. The call is automatically put on hold, and a **Conf. with target** screen showing all calls on hold appears.

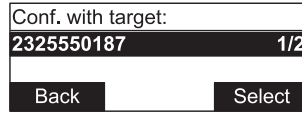

3. Highlight the desired call and press **Select**. You can now talk to the caller you selected.
4. Press **Conf**. The conference begins and the conference screen appears.



### To end a conference call:

Press one of the following soft keys:

- **End**, which hangs up on both calls.
- **Split**, which puts both calls on hold. The screen shows information for the second call.
- **Bridge**, which joins both calls and returns your phone to idle mode.

### Setting up a Network Conference:

A Network Conference is hosted by your service provider and allows multiple parties to join a conference. A Network Conference works in a similar way to the regular conference described above, except that the **Split** and **Bridge** functions will not be available.

In addition, the soft keys **Add** and/or **AddCall** will appear during a conference, allowing you to add more parties to the ongoing conference call.

# Using the Phone

## Retrieving messages

---

The phone alerts you when you have a new message. The Message Waiting indicator also turns on whenever you have new messages.

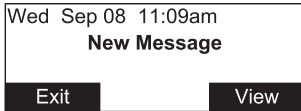

On the New Message alert screen, you can press:

- **Exit** to return to the Idle screen.
- **View** to access your messages. The Message menu appears.

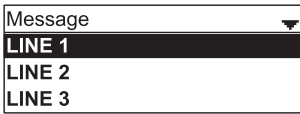

The Message menu displays the mailboxes you can access from your phone. If your phone has more than one line, you may be able to access multiple mailboxes. Press **▲** or **▼** to highlight the desired mailbox and press **SELECT** to access messages in that mailbox.

When there is no New Message alert screen, you can access the Message menu using the deskset menu.

### To view the Message menu:

1. When the phone is idle, press **Menu**.
2. With **Features** highlighted, press **SELECT**.
3. Press **▼** to highlight **Message**, and then press **SELECT**.



The Message menu appears.



4. On the Message menu, highlight the desired line and then press **SELECT**.

# Using the Phone

## Using a shared line

---

Your phone may be configured to have one or more shared lines. This means that a group of phones, including yours, can make and receive calls on the same line. The shared line can have more than one programmable key assigned to it. Ask your system administrator for the configuration that applies to your deskset.

Incoming calls on a shared line will ring every deskset that shares that line. When someone answers the call, the other desksets stop ringing and return to idle mode. In contrast, calls on a private line will ring only your deskset.

Incoming calls on a shared line look identical to private-line calls, except that the **Forward** soft key does not appear on the incoming call screen.



## When to Use a Private Line Instead of a Shared Line

Your system administrator should label your deskset feature keys according to the type of line. The labels should indicate which keys apply to the shared line(s) and which keys apply to private lines. In general, you should use private lines for direct calls to other desksets within your organization. If you use a shared line to call other desksets, all the other desksets that use that line will ring.

## Call monitoring

---

One of the main features of shared lines is the ability to monitor call activity. You can monitor the call activity by observing the Line key LED. On your deskset, the LED is steady orange when a call has been answered at another deskset, and flashes orange slowly when the user at another deskset puts a call on hold. See “Programmable feature key lights” on page 19.

## Putting a shared-line call on hold

---

After you answer a call on a shared line, you have two options for putting that call on hold.

- You can put a call on hold by pressing the **HOLD** key. This puts a call on “normal” hold. On a shared line, this means that other shared-line users can see that the call is on hold, as indicated by the flashing orange Line key LED. Other users can retrieve the call by pressing the flashing Line key. Your deskset will return to idle mode. Putting a call on hold this way can be useful if you want to hand off the call to someone else, or if you want to pick up the held call at another deskset.
- You can also put a call on “private” hold, which means that other users cannot see that the call is on hold. Their Line key LEDs continue to show a steady orange, indicating that the call is active. This is useful if you plan to resume the held call on the same deskset.

# Using the Phone

## Putting a shared-line call on hold (continued)

---

When you transfer a call or start a conference call, the other call is put on private hold automatically. During the transfer or conference setup process, no other desksets can retrieve the call on hold.

As well, when you are on a call and you answer another incoming call or retrieve another call on hold, your first call is put on private hold automatically.

### To put a call on private hold manually:

- Press and hold the **HOLD** key for 2 seconds.

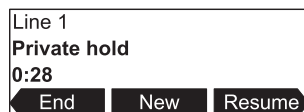

## “Barging in”

---

When you have a shared line, it may be possible to “bargue in,” that is, join a call in progress at another deskset that uses that shared line. The result of barging in is that you create a “bridged call” between you and the people whose call you joined. You and the others can then converse. Note that any other shared-line user can barge in on the call as well.

**Note:** The ability to barge in on calls is a configurable setting for your deskset. Only your system administrator can enable this setting. Your deskset may have shared lines, but be unable to barge in on calls. If barging in is disabled on your deskset, pressing the key with the steady orange LED will do nothing.

Bridged calls differ from conference calls in that you can join a call in progress at any time. However, because the caller ID of the active call is not visible to you, other participants in the call may need to notify you of an appropriate time to join.

Bridged calls can also have any number of participants, unlike conference calls. The number of participants on a bridged call depends on the number of desksets sharing that line and may be limited by system or network capabilities.

### To barge in on a call:

- Press the desired line key that has a steady orange LED, indicating an active call on a shared line.

You join the call already in progress.

To leave the call, press **End**. The other participants can continue their bridged call.

**Note:** If you are unable to barge in on a call, it may be because the other call is not currently in progress. A line key with a steady orange LED can also indicate that the call is on private hold at the other deskset, or that the other deskset is dialing a number and no call is established yet.



# Using the Phone

## Busy lamp field

As with shared lines, you can monitor call activity using Busy Lamp Field (BLF) keys. However, BLF keys and LEDs represent activity on an individual deskset, not on a line. Keys configured for BLF allow you to monitor call activity for the extension only. You can use the BLF key as a quick dial key to call the extension and intercept ringing calls.

**Note:** Your system administrator sets up Busy Lamp Field keys. Your key labels should identify the BLF keys and which extensions they monitor. The BLF feature may not be available on your deskset.

For BLF LED states, see “Programmable feature key lights” on page 19.

### To dial a monitored extension:

- Press the BLF key for that extension. The monitored extension can be idle, or have an active or held call.

Your deskset dials the extension using the first available line key. When the other person answers, your deskset indicate two active calls: one active call on the line key that you dialed out on, and one active call on the BLF key of the monitored extension you called.

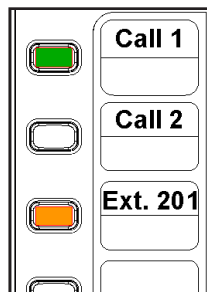

### To answer a call ringing at a monitored extension:

- Press the flashing orange BLF key for the desired extension.

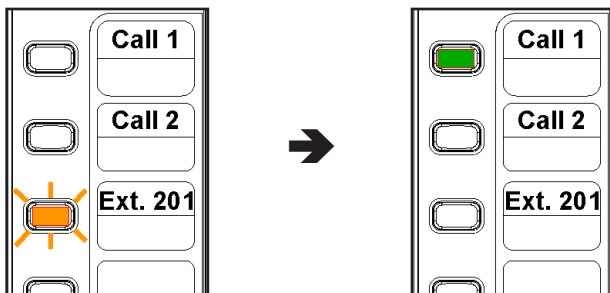

Your deskset answers the call on the first available line key.

# Using the Phone

## Paging

---

Your phone supports two types of paging: server-based paging and multicast paging. An incoming page may interrupt any active calls you are on, depending on how your system administrator has configured the paging function.

### To send a server-based page:

1. Press the Page feature key.  
Your phone dials the Page Feature Access Code.

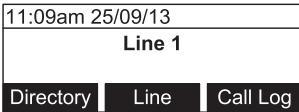

2. Follow the voice prompts to page.

### To send a multicast page:

1. Press the Multicast Page feature key.  
You will hear a paging tone before your phone broadcasts a page to the assigned paging zone.

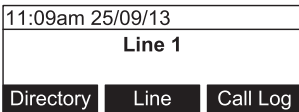

2. Press **End** to terminate the page.

## Automatic Call Distribution

---

If you are subscribed to Automatic Call Distribution (ACD), pressing the ACD feature key will display the ACD State Menu:

### To set your ACD state:

1. Press the ACD feature key.  
The ACD State list menu appears.

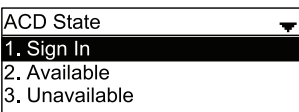

2. Press ▲ or ▼ to select the desired state, and then press **SELECT**.

If you select “Unavailable”, then you will have the option of entering a reason code.

# Phone Features

## Using the Features menu

---

On the Features menu, you can manage incoming calls, use the Directory, access your messages, view your call history, and manage your speed dial numbers.

## Navigating menus

---

To select a submenu on a numbered list, you can:

- Press ▲ or ▼ to highlight the desired menu, then press **SELECT**.
- Press the dial pad key that matches the number of the desired menu.

### To access the Features menu:

1. When the phone is idle, press **MENU**.  
The Main Menu appears.
2. If necessary, press ▲ or ▼ to highlight **Features**, and then press **SELECT**.  
The Features menu appears.

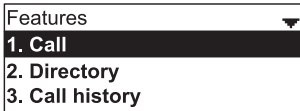

The Features menu includes the following items:

Setting	See page...	Description
1. Call	36	Manages how your phone handles incoming calls.
2. Directory	40	Stores contact information and call contacts.
3. Call History	43	Lists incoming and outgoing call information.
4. Message	30	Accesses your voicemail.
5. Speed dial	46	Accesses your list of speed dial numbers.

# Phone Features

## Using the Call menu

On the Call menu, you can manage how your phone handles incoming calls. The settings available on the Call menu include:

Setting	See page...	Description
1. Do Not Disturb	37	Silences incoming ringing and paging. Do Not Disturb (DND) is set on a per-line basis. The system administrator can enable you to answer incoming calls when DND is on. When DND answering is enabled, the Line key flashes for incoming calls and the incoming call screen appears. If DND answering is disabled, the incoming call will be terminated.
2. Call forward	37	Automatically forwards incoming calls depending on the setting. You can enable the following types of call forwarding: <ul style="list-style-type: none"><li>• Call forward always: incoming calls are forwarded immediately and the phone does not ring.</li><li>• Call forward busy: incoming calls are forwarded if all your available lines are busy.</li><li>• Call forward no ans: incoming calls are forwarded after the no answer delay expires.</li></ul>
3. Block anonymous	38	Enables the phone to reject incoming calls that have no caller ID.
4. Dial as anonymous	38	Enables the phone to make outgoing calls with the Caller ID hidden from the far end.
5. Missed call alert	39	Enables the missed call alert screen.
6. Call waiting	39	Enables or disables incoming call alerts while you are on another call.

### To use the Call menu:

1. When the phone is idle, press **MENU**.
2. If necessary, press ▲ or ▼ to highlight **Features**, and then press **SELECT**.
3. If necessary, press ▲ or ▼ to highlight **Call**, and then press **SELECT**.  
The Call menu appears.

Call
<b>1. Do Not Disturb</b>
2. Call forward
3. Block anonymous

# Phone Features

## Using the Call menu (continued)

---

### To set Do Not Disturb:

1. From the Call menu, if necessary, press ▲ or ▼ to highlight **Do Not Disturb**.
2. Press **SELECT**.
3. On the Do Not Disturb menu, highlight the line for which you want to turn Do Not Disturb On or Off.

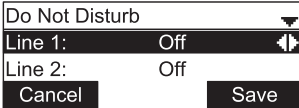

4. When the desired line is highlighted, press ◀ or ▶ to turn Do Not Disturb On or Off.
5. Press **Save**.

When Do Not Disturb is on for your default line,  appears on the idle screen.

### To set Call forward:

1. From the Call menu, press ▼ to highlight **Call forward**.
2. Press **SELECT**.  
The Call forward menu appears.

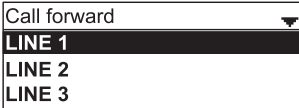

3. Highlight the line for which you want to configure call forward settings, and then press **SELECT**.
4. On the next screen, press ▼ to highlight the desired option:
  - Call forward always
  - Call forward busy
  - Call forward no ans.



5. Press **SELECT**.

# Phone Features

## Using the Call menu (continued)

---

6. On the next screen, press ◀ or ▶ to turn call forwarding On or Off.

LINE 1
Always: Off
Number:
Cancel Save

7. Press ▼.
8. Enter the number to which you would like to forward calls.
9. (If you selected **Call forward no ans** earlier) Press ▼.
10. (If you selected **Call forward no ans** earlier) Press ◀ or ▶ to set the No answer delay between 1 to 10 rings.
11. Press **Save**.

When Call forward is on for your default line,  appears on the idle screen.

**Note:** Your system administrator can also configure programmable keys to turn Call forward always, Call forward busy, and Call forward no answer on or off.

### To block anonymous callers:

1. From the Call menu, press ▼ to highlight **Block anonymous**.
2. Press **SELECT**.

The Block anonymous menu appears.

Block anonymous
Line 1: Off
Line 2: Off
Cancel Save

3. Highlight the desired line, and then press ◀ or ▶ to turn anonymous call blocking On or Off for that line.
4. Press **Save**.

### To dial as an anonymous caller:

1. From the Call menu, press ▼ to highlight **Dial as anonymous**.
2. Press **SELECT**.

The Dial as anonymous menu appears.

Dial as anonymous
Line 1: Off
Line 2: Off
Cancel Save

3. Highlight the desired line, and then press ◀ or ▶ to turn anonymous call dialing On or Off for that line.
4. Press **Save**.

# Phone Features

## Using the Call menu (continued)

---

### To enable missed call alerts:

1. From the Call menu, press ▼ to highlight **Missed call alert**.
2. Press **SELECT**.

The Missed call alert menu appears.

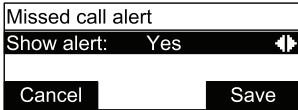

3. Press ◀ or ▶ to turn missed call alerts on or off.
4. Press **Save** .

### To enable call waiting alerts:

1. From the Call menu, press ▼ to highlight **Call waiting**.
2. Press **SELECT**.

The Call waiting menu appears.

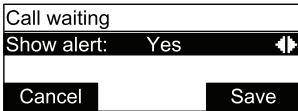

3. Press ◀ or ▶ to turn call waiting alerts on or off.
4. Press **Save** .

When **Show alert** is on and you are on a call, incoming calls are displayed on the screen. When **Show alert** is off, incoming calls are rejected and no notification appears on the screen. See also “Call Waiting Settings” on page 63.

# Phone Features

## Using the local directory

---

You can store the names and phone numbers for up to 200 contacts in the deskset directory. Once directory entries are saved, you can dial them directly from the directory. You can also search directory entries by first or last name.

When adding an entry, you can enter numbers for work, mobile, and other. You can also select a ringtone for that contact. Later, you can edit entries if their contact information changes.

### To view the local directory:

1. When the phone is idle, press **MENU**.
2. With **Features** highlighted, press **SELECT**.
3. Press **▼** to highlight **Directory**, and then press **SELECT**.  
The Directories screen appears, listing all your available directories and the blacklist. Any directories other than Local are server-based and will vary with your installation. You can edit the Local directory and the blacklist.



4. With **Local** highlighted, press **SELECT**.  
The Local directory appears, showing the first entry (sorted alphabetically by first name).



5. Press **▲** or **▼** to view other entries.

The following soft keys are available when viewing a directory entry:

<b>Back</b>	Returns to Directory list screen	<b>LastNme</b>	Sorts the list by last name from the top of the list	<b>Type</b>	Displays the contact's other numbers: Work, Mobile, Other
<b>Dial</b>	Dials the entry	<b>Edit</b>	Allows you to change the entry	<b>Search</b>	Allows you to search the list alphabetically by first or last name
<b>Add</b>	Allows you to add a new entry	<b>Delete</b>	Deletes the entry	<b>Del. all</b>	Deletes all entries



# Phone Features

## Using the local directory (continued)

---

### To call a contact:

1. Press ▲ or ▼ or **Search** to view the desired directory entry.
2. To view other numbers for the entry, press **Type** .
3. When the desired number appears, press **Dial** .

**Note:** If you view a directory entry when you have already entered digits in dial mode, an **Insert** soft key appears instead of **Dial** . Press **Insert** to add the entry's number onto the existing digits. You can use this feature when making a call, forwarding a call, transferring a call, and setting up a conference call.

### To add a directory entry:

1. When viewing a directory entry, press ◀ or ▶ until the **Add** soft key appears.
2. Press **Add** .  
A blank directory entry appears.
3. Use the dial pad keys to enter the first name, last name, and contact numbers.
  - Press **ABC** to switch between entering upper-case letters, lower-case letters, and numbers.
  - Press **Backspc** to delete incorrect characters.
  - After completing a line, press ▼ to move to the next line.
4. When you have entered the desired information and selected the ringtone you want to use for this contact, press **Save** .

### To edit a directory entry:

1. When viewing the desired directory entry, press ◀ or ▶ until the **Edit** soft key appears.
2. Press **Edit** .  
The directory entry edit screen appears.
3. Use the dial pad keys to change the first name, last name, and contact numbers as desired.
  - You can edit the name and numbers, and change the ringtone.
  - Press **ABC** to switch between entering upper-case letters, lower-case letters, and numbers.
  - Press **Backspc** to delete incorrect characters.
  - After completing a line, press ▼ to move to the next line.
4. Press **Save** .

# Phone Features

## Using the local directory (continued)

---

### To search directory entries:

1. From the Directories screen or from a directory entry, press **Search** . The Local directory search screen appears.

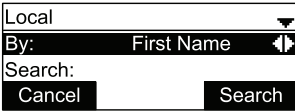

2. To filter your search by first name or last name, press ◀ or ▶.
3. Press ▼ to move to the Search field.

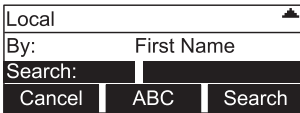

4. Press a dial pad key to enter a letter for your first name or last name search. Press **2** once for A, or three times for C, for example.
5. Press **Search** . The deskset searches for the first name or last name beginning with the letter you entered.

The first entry found appears. If more than one entry was found, press ▲ or ▼ to view other entries.

### To delete a directory entry:

1. Press ▲ or ▼ or **Search** to view the desired directory entry.
2. Press ◀ or ▶ until the **Delete** soft key appears.

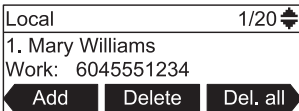

3. Press **Delete** .
4. When the confirmation screen appears, press **Yes** .

### To delete all directory entries:

1. From a directory entry, press ▲ or ▼ until the **Del. all** soft key appears.
2. Press **Del. all** .
3. When the confirmation screen appears, press **Yes** .

# Phone Features

## Blacklist

---

The directory also includes a blacklist, which is a list of numbers that cannot reach your phone. If you experience nuisance calls, you can add the callers' contact information to the blacklist. Calls from blacklisted numbers will not ring your phone, or be recorded in your call history. The Blacklist can be viewed and edited in the same way as the Local directory but is a completely separate directory listing.

## Call history

---

The call history provides available name and number information for the last 200 incoming and outgoing calls. The newest entries replace the oldest. You can view call history information for:

- All calls—all categories of calls
- Missed calls—incoming calls that were not answered
- Received calls—incoming calls that you answered, forwarded or rejected
- Dialed calls—all outgoing calls. You can use this as a redial list.

### To view the call history:

1. When the phone is idle, press **Menu**.
2. If necessary, press **▲** or **▼** to highlight **Features**, then press **SELECT**.
3. Press **▲** or **▼** to highlight **Call History**, then press **SELECT**.  
The Call History screen appears.

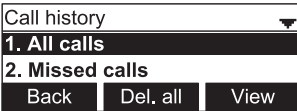

4. Press **▼** to highlight the desired call history folder.
5. Press **View** to see call history entries in the highlighted folder.  
The first entry appears.

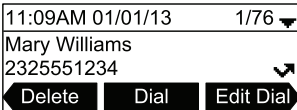

If the folder is empty, the message **No entries to display** appears.

6. Press **▼** to view more entries.

The call history entry screen shows the time, date, name and number of the call, the number of entries in the folder, along with an icon indicating the type of call.

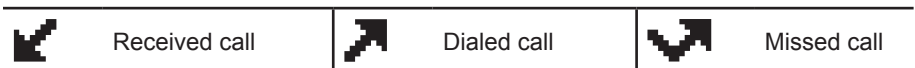

# Phone Features

## Call history (continued)

The following soft keys are available when viewing a call history entry:

<b>Delete</b>	Deletes the entry	<b>Dial</b>	Dials the entry	<b>Edit Dial</b>	Displays the predial screen so you can edit the number before dialing
<b>Save</b>	Saves the call information to the local directory				

### To call a call history entry:

1. While viewing the desired entry, press **Dial** . The phone dials the number immediately.

–or–

Press **Edit Dial** . The predial screen appears, allowing you to edit the number before pressing **Dial** .

**Note:** If you view a call history entry when you have already entered digits in dial mode, an **Insert** soft key appears instead of **Dial** . Press **Insert** to add the entry's number onto the existing digits. You can use this feature when making a call, forwarding a call, transferring a call, and setting up a conference call.

### To add a call history entry to the directory:

1. While viewing the desired entry, press ◀ or ▶ until the **Save** soft key appears.

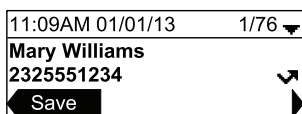

2. Press **Save** .
3. On the **Save to** menu, select the location to which you want to save the entry.
  - To save the entry to your directory, highlight **Local** and then press **SELECT**.

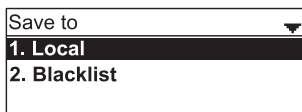

- To save the entry to your blacklist, highlight **Blacklist** and then press **SELECT**.

- The directory add/edit screen appears. The deskset automatically fills in the name and number, if available.

First name:	Mary Williams	
Last name:		
Work:	2325551234	
Backspc	ABC	Save

- If necessary, edit the name and number.  
Press ▼ to move the cursor to the next line.
  - Press **Backspc** to delete incorrect characters.
- Press **Save** to save the entry.

#### To delete a single call history entry:

- While viewing the desired entry, press **Delete** .

#### To delete multiple call history entries:

- While viewing the list of call history folders, press ▼ to highlight the folder for which you would like to delete all entries: All calls, Missed calls, Received calls, or Dialed calls.

Call history	▼	
<b>1. All calls</b>		
<b>2. Missed calls</b>		
Back	Del. all	View

- Press **Del. all** .
- When the confirmation screen appears, press **Yes** .

Delete all All calls entries?	
Yes	No

# Speed Dial

The speed dial menu allows you to enter up to 10 numbers that you dial frequently. To dial a speed dial number, press and hold the dial pad key that matches the speed dial entry number (for entry 10, press and hold **0**).

You can also enter speed dial numbers using the WebUI. See “Speed Dial” on page 70.

## Entering speed dial numbers

---

### To add a speed dial entry:

1. When the phone is idle, press **Menu**.
2. With **Features** highlighted, press **SELECT**.
3. Press **▼** to highlight **Speed dial**, and then press **SELECT**.

The Speed dial menu appears.



A screenshot of the Speed dial menu. At the top, there is a header "Speed dial" with a downward arrow. Below it, there are two entries: "1. <Empty>" and "2. <Empty>". At the bottom, there are two buttons: "Back" and "Add".

4. Press **▼** to highlight a speed dial entry marked **<Empty>**.
5. Press **Add**.

A blank speed dial entry appears.

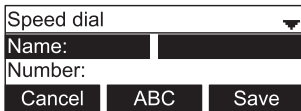

A screenshot of the Speed dial entry form. At the top, there is a header "Speed dial" with a downward arrow. Below it, there are two input fields: "Name:" and "Number:". At the bottom, there are three buttons: "Cancel", "ABC", and "Save".

6. Use the dial pad keys to enter the name and number.
  - Press **123** to switch between entering numbers, lower-case letters, and upper-case letters.
  - When you start entering characters, the **Cancel** soft key changes to **Backspc**. Press **Backspc** to delete incorrect characters.
  - After completing a line, press **▼** to move to the next line.
7. Press **▼** and then press **◀** or **▶** to select the line you want to use for this speed dial entry.
8. When you have entered the desired information, press **Save**.

# Cordless Headset

## Registering an optional cordless headset

---

You can register one cordless headset to a VSP725 deskset. When a deskset has a cordless accessory, the deskset and headset are all part of the same extension, and only one device can be used at a time.

**Note:** The headset must be in the charger, otherwise registration cannot proceed.

### To register the cordless headset:

1. When the phone is idle, press **Menu**.
2. Press ▼ to highlight **User Settings**, and then press **SELECT**.
3. Press ▼ to highlight **DECT headset**, and then press **SELECT**.

The DECT headset menu appears.



4. Lift the cordless headset out of its charging base, and then place it back in the charger.
5. With **Register** highlighted, press **SELECT** on the deskset. **Registering...** appears while the deskset searches for the headset.

When registration is complete, **Registration succeeded** appears and the ON/OFF light on the cordless headset turns solid blue.

The DECT headset menu appears.

**Note:** Registration can be terminated by pressing **CANCEL** on the deskset.

If the cordless headset was registered to another deskset, it must be deregistered first. See "Deregistering a cordless headset".

# Cordless Headset

## Deregistering a cordless headset

---

You must deregister a cordless headset from its original deskset before you can register it to a different deskset.

### To deregister a cordless headset:

1. When the phone to which the headset is registered is idle, press **Menu**.
2. Press ▼ to highlight **User Settings**, and then press **SELECT**.
3. Press ▼ to highlight **DECT Headset**, and then press **SELECT**.  
The DECT headset menu appears.
4. Press ▼ to highlight **Deregister**, and then press **Select** .

The deskset screen displays **DECT headset is deregistered**. The cordless headset ON/OFF light flashes twice every five seconds to indicate it is not registered.

The DECT headset menu appears.

## Deregistering the cordless headset without the deskset

---

Cordless headsets can also be deregistered using the headset. You can use this method when you cannot use the deskset for standard deregistration. The deskset may be out of range or may have been removed from the system. Check your headset manual for deregistration instructions applicable to your model.

### Cordless accessory registration and deregistration time-out

---

If the cordless device is registered to another deskset or telephone, it must be deregistered first. See “Deregistering a cordless headset”.

For security reasons, the registration process on both the deskset and the cordless accessory terminates after the time-out period of two minutes if registration is not successful.

If the registration process times out on the cordless accessory, the cordless accessory resets itself. If the registration process times out on the deskset, it displays **Registration Failed** and returns to Idle mode.

If cordless headset registration fails, the ON/OFF light on the headset flashes twice every five seconds. To reset the headset, lift the headset out of its charging base, place it back in the charger, and try the registration process again.



# Cordless Handset

## Registering an optional cordless handset

You can register one VSP601 DECT cordless handset to a VSP725 deskset. When a deskset has a cordless accessory, the deskset and handset are all part of the same extension, and only one device can be used at a time.

**Note:** Make sure the handset has a charged battery before proceeding. Also make sure the deskset is powered on and is idle.

### To register the cordless handset:

1. Press **MENU** on the handset. The Main Menu appears.
2. Press **▼** to scroll to **User settings** and press **SELECT**.
3. Press **▼** to scroll to **Registration** and press **SELECT**.
4. With **Handset** highlighted, press **SELECT**. The handset asks you which device you want to register to. Press **DESKSET**.
5. The handset screen displays instructions. Press **NEXT** to continue reading the instructions.
6. On the phone, press **Menu**.
7. Press **▼** to highlight **User Settings**, and then press **SELECT**.
8. Press **▼** to highlight **DECT handset**, and then press **SELECT**.

The DECT handset menu appears:

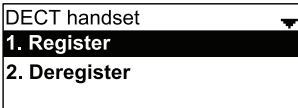

9. With **Register** highlighted, press **SELECT** on the deskset. **Registering...** appears while the deskset searches for the handset.
10. Press the **#** key on the handset. The screen shows **Please wait...**

The registration process takes up to 10 seconds. When registration is complete, **Registration succeeded** appears on the deskset. The handset displays **Handset Registered**.

If the handset fails to register, place it in the charger for a few seconds, remove it and repeat the registration procedure.

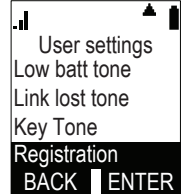
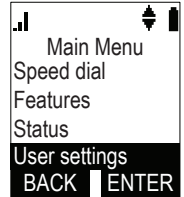

# Cordless Handset

## Deregistering the cordless handset

---

Before using the cordless handset with a different deskset, you must deregister the handset from the device to which it is currently registered.

### To deregister using the handset:

1. Press **MENU** on the handset. The Main Menu appears.
2. Press **▼** to scroll to **User settings** and press **SELECT**.
3. Press **▼** to scroll to **Registration** and press **SELECT**.
4. Press **▼** to highlight **Deregistration** and press **SELECT**.
5. Enter the PIN and then press **OK** to begin deregistration. The default PIN is 1592.

**Note:** When deregistering the handset from a deskset that has been upgraded to software version 1.1.1.1 or later:

- If the deskset was not reset to factory defaults after upgrading, the PIN to begin deregistration is 1591.
- If the deskset was reset to factory defaults after upgrading, the PIN to begin deregistration is 1592.

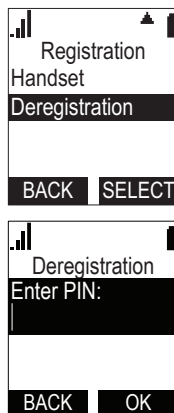

### To deregister using the deskset:

1. On the deskset, press **MENU** when idle.
2. Press **▼** to highlight **User Settings**, and then press **SELECT**.
3. Press **▼** to highlight **DECT handset**, and then press **SELECT**.

The DECT handset menu appears.

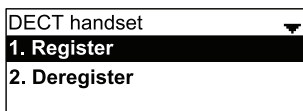

4. Press **▼** to highlight **Deregister**, then press **Select**.
5. Press **Yes** to confirm deregistration.

The deregistration process takes up to 10 seconds to complete. The deskset screen displays **DECT handset is deregistered**.

**Note:** The handset enters an energy-saving charging mode after being deregistered. All cordless telephone functions except handset-battery charging are disabled. Energy-saving charging mode is deactivated after the handset registers to the deskset.

# Status

## Finding the firmware version

---

### To view the firmware version of your phone:

1. When the phone is idle, press **MENU**.
2. On the Main menu, press ▼ to highlight **Status**, and then press **SELECT**.
3. On the Status screen, press ▼ to highlight **Product Info**, and then press **SELECT**.



4. On the Product Info screen, press ▼ until **Firmware Ver.** appears.

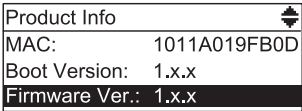

# Configuring the Phone

You can configure the phone using one of two methods:

1. The User Settings menu on the phone.
2. The WebUI, which you access using your Internet browser.

This section describes the User Settings menu. For information about the WebUI, see page 58.

## Using the User Settings menu

---

**To view the User Settings menu:**

1. Press **MENU**.
2. Press **▼** to highlight **User Settings**, and then press **SELECT**, or press **3** (User Settings) on the dial pad.

The User Settings menu appears.



The User Settings are:

Setting	Options
1. Preferences	Language Date & Time (Clock time, Clock date, Time zone, Daylight savings, NTP server, Set manually) Restart phone
2. Display	Contrast (Level 1–7) Backlight ON (Off, Low, Medium, High) Backlight idle (Off, Low, Medium, High) Timeout (10–60 seconds)
3. Audio	Ringer tone (Line 1, Line 2...) Key tone (On, Off) Audio mode (Speaker, Headset)
4. Programmable keys	Keys 1 to 24
5. DECT headset	Register (see “Registering an optional cordless headset” on page 47) Deregister
6. DECT handset	Register (see “Registering an optional cordless handset” on page 49) Deregister

# Configuring the Phone

## Preferences

---

Use the Preferences menu to set the language, date and time formats, and restart the phone.

### To use the Preferences menu:

1. Press **MENU**, then select **User Settings**, or press **3**.

The User Settings menu appears.



2. On the User Settings menu, ensure that **Preferences** is highlighted and then press **SELECT**.

The Preferences menu appears.

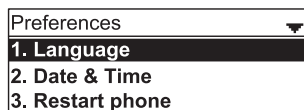

3. Press **▲** or **▼** to highlight the desired option, and then press **SELECT**. The available options are:
  - Language
  - Date & Time
  - Restart phone

## Setting the language

---

1. From the Preferences menu, press **▲** or **▼** to highlight **Language**, and then press **SELECT**.

The Language menu appears.

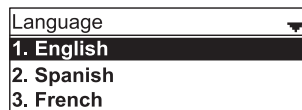

2. Press **▲** or **▼** to highlight the desired language.
3. Press **SELECT**.

## Setting the date and time

---

1. From the Preferences menu, press **▼** to highlight **Date & Time**, and then press **SELECT**.

The Date & Time menu appears.

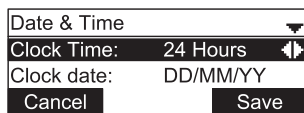

# Configuring the Phone

## Setting the date and time (continued)

---

### To set the time format:

1. From the Date & Time menu, ensure that **Clock Time** is highlighted.
2. Press ◀ or ▶ to select a 12-hour clock (12am/pm) or 24-hour clock.
3. Press **Save** .

### To set the date format that appears on the idle screen:

1. From the Date & Time menu, press ▼ to highlight **Clock date**.
2. Press ◀ or ▶ to select the desired date format (DD/MM/YY, MM/DD/YY, YY/MM/DD)
3. Press **Save** .

### To set the Time Zone:

1. From the Date & Time menu, press ▼ to highlight **Time Zone**.
2. Press **Edit** .
3. Press ▲ or ▼ to select a setting. The time zone is set as an offset from GMT. For example, EST is -5, and PST is -8.
4. Press **Save** .

### To enable or disable Daylight Savings Time adjustment:

1. From the Date & Time menu, press ▼ to highlight **DST**.
2. Press ◀ or ▶ to select Enabled or Disabled.
3. Press **Save** .

### To enable or disable the NTP (Network Time Protocol) server:

1. From the Date & Time menu, press ▼ to highlight **NTP server**.
2. Press ◀ or ▶ to select Enabled or Disabled.
3. Press **Save** .

**Note:** If the NTP server is disabled, you must manually set the time and date. This setting is valid only if the system administrator has already configured the Network Time settings. For more information, see the VSP725 Deskset Administrator and Provisioning Guide.

### To manually set the Year, Month, Day, Hour and Minute:

1. From the Date & Time menu, press ▼ to highlight **Set manually**.
2. Press **SELECT**.

**Note:** If the NTP server is enabled, you cannot modify this setting. See “To enable or disable the NTP (Network Time Protocol) server” above.

3. For each setting, press ◀ or ▶ to select the desired setting, and then press ▼ to move to the next line.
4. When you have finished, press **Save** .

# Configuring the Phone

## Display

---

Use the Display menu to set screen appearance and backlight behavior.

### To use the Display menu:

1. Press **MENU**, then select **User Settings**, or press **3**.  
The User Settings menu appears.
2. Press **▲** or **▼** to highlight **Display**, then press **SELECT**.  
The Display menu appears.

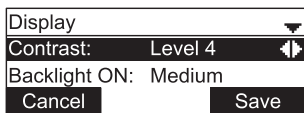

### To set the contrast level:

1. From the Display menu, ensure that **Contrast** is highlighted.
2. Press **◀** or **▶** to set the contrast level from 1 to 7 (4 is the default setting).
3. Press **Save** .

### To set the backlight level that applies when the phone is active:

1. From the Display menu, press **▼** to highlight **Backlight ON**.
2. Press **◀** or **▶** to select Off, Low, Medium, or High (High is the default setting).
3. Press **Save** .

### To set the backlight level that applies when the phone is idle:

1. From the Display menu, press **▼** to highlight **Backlight idle**.
2. Press **◀** or **▶** to select Off, Low, Medium, or High (Off is the default setting).
3. Press **Save** .

### To set the backlight off timeout:

1. From the Display menu, press **▼** to highlight **Timeout**.
2. Press **◀** or **▶** to select between 10 and 60 seconds at 5-second intervals (30 seconds is the default setting).
3. Press **Save** .

# Configuring the Phone

## Audio

---

Use the Audio menu to pick one of ten ringer tones, turn key tones on and off, or select the default audio mode.

**Note:** To adjust the ringer volume, press the deskset **VOLUME ▼** or **▲** keys while the phone is idle.

### To use the Audio menu:

1. Press **MENU**, then select **User Settings**, or press **3**.

The User Settings menu appears.

2. Press **▼** to highlight **Audio**, then press **SELECT**.

The Audio menu appears.

Audio ▼
<b>1.Ringer tone</b>
2.Key tone
3.Audio mode

### To select different ringer tones for each line:

1. From the Audio menu, ensure that **Ringer tone** is highlighted and then press **Select**.
2. On the Ringer tone menu, press **▼** (if necessary) to highlight a line for which to select a ringer tone and then press **Select**.

Ringer tone ▼
<b>1. LINE 1</b>
2. LINE 2
3. LINE 3

3. On the selected line screen, press **◀** or **▶** to select one of ten ringer tones. The default is 1. Ringer tone samples play when selected.

LINE 1
Ringer tone: Ringtone 1 ◀▶
Cancel Save

4. After selecting the desired ringer tone, press **Save**. To exit without saving a new ringer tone, press **Cancel**.



# Configuring the Phone

## To set the key tone:

1. From the Audio menu, press ▼ to highlight **Key tone** and then press **SELECT**.

The Key tone menu appears.

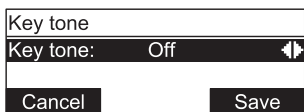

2. On the Key tone menu, press ◀ or ▶ to turn key tones on or off. When off, key presses are silent.
3. Press **Save**.

## To set the audio mode:

1. From the Audio menu, press ▼ to highlight **Audio mode** and then press **SELECT**.

The Audio mode menu appears.

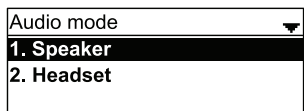

2. On the Audio mode menu, press ▼ to highlight the desired audio mode (Speaker, Headset, or DECT Headset).
3. Press **SELECT**.

When you press a Line key or **Answer**, the call is started or answered using the selected audio mode. Lifting the handset takes priority in all instances.

## Configuring the programmable keys

---

You can configure the Programmable Keys on the Deskset. You can also configure these keys on the WebUI (see “Programmable Keys” on page 64).

## To configure the programmable keys:

1. Press **MENU**, then select **User Settings**, or press **3**.

The User Settings menu appears.

2. Press ▼ to highlight **Programmable keys**, and then press **SELECT**.

The Programmable keys menu appears.

3. Press ▼ to highlight the key to configure, and then press **Edit**.

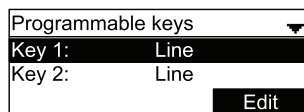

4. Select a PFK type, and then press **SELECT**.

Depending on the PFK type, the screen may prompt you to configure additional settings. For more details on PFK types, see “Programmable Keys” on page 64.

# WebUI

## Using the WebUI

---

Use an Internet browser to access the Web User Interface (WebUI) that resides on your deskset. After you log on to the WebUI, you can configure the following features:

- Call Settings
- User Preferences
- Programmable Keys
- Speed Dial
- Local Directory
- Blacklist
- Call History
- User Password

The WebUI also has a Status page, where you can view status and information.

### To access the WebUI:

1. Ensure that your computer is connected to the same network as your deskset. Your computer may already be connected to the network through the PC port on the back of your deskset.
2. Find the IP address of your phone:
  - a. When the phone is idle, press **MENU**.
  - b. Press **▼** to highlight **Status**, and then press **SELECT**. The Status menu appears.

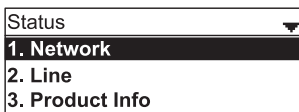

- c. On the Status menu, ensure that **Network** is highlighted, and then press **SELECT**. The Network screen appears.

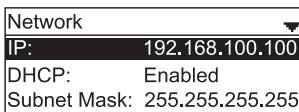

- d. On the Network screen, note the IP Address.
3. On your computer, open an Internet browser. Depending on your browser, some of the pages presented here may look different and have different controls.
  4. Type the phone IP address in the browser address bar and press **ENTER** on your computer keyboard. A Login page appears.



5. Under **User Name**, enter **user**.
6. Under **Password**, enter **user**, or your own password, if you have created one. You can create or change a password after you log on.
7. Click **Log In**. The WebUI appears.

Click topics from the navigation bar at the top of the page, and then click the desired setting on the left side of the WebUI to see the page for that setting. You view and change settings in two different types of fields: drop-down lists and entry fields into which you type information. For your security, the WebUI times out after 10 minutes, so if it is idle for that time, you must log on again.

The remaining procedures in this section assume that you have already logged on to the WebUI.

## Status

The Status page shows:

- **General** information about your phone, including model, MAC address, and firmware version.
- **Account Status** information about your SIP account registration.
- **Network** information regarding your phone's network address and network connection.
- **Cordless Status** indicating whether a cordless headset or cordless handset is registered to the deskset.

The Status page has no settings that you can change. You may need some of the status information for troubleshooting purposes.

STATUS	STATUS	SYSTEM	CONTACTS	SERVICING
System Status	<b>General</b>			
	Model:	VSP725		
	Serial Number:	SM40000617		
	MAC Address:	00:12:2A:41:98:4F		
	Boot Version:			
	Firmware Version:	0.64.Z.26887-ENG		
	V-Series:	0.64.Z.26887-ENG		
	Hardware Version:	1		
	EMC version:	1		
	<b>Account Status</b>			
	Account 1	Registered		
	Account 2	Not Registered		
	Account 3	Not Registered		
	<b>Network</b>			
	LAN Port IP Address:	10.88.51.96		
	IP type:	DHCP		
	Subnet Mask:	255.255.0.0		
	Link Status:	Connected		
	Gateway:	10.88.3.149		
	Primary DNS:	10.88.162.31		
	Secondary DNS:	10.88.162.10		
	Network Time Settings	us.pool.ntp.org		
	<b>Cordless Status</b>			
	Headset:	Not Registered		
	Handset:	Not Registered		

# WebUI

## Call Settings

To view the call settings, click **SYSTEM** in the WebUI header, and then click **Call Settings** in the sidebar. You can configure call settings for each account that is available to your phone. Click **Account 1**, **Account 2**, and so on to select the call settings page for the desired account.

Call Settings include Do Not Disturb and Call Forward settings. You can also set Do Not Disturb and Call Forward using the deskset. See “Using the Call menu” on page 36.

When you have finished changing settings on this page, click **Save** to save them.

**SYSTEM**  
Call Settings  
Account 1  
Account 2  
Account 3  
User Preferences  
Programmable Keys  
Speed Dial

STATUS SYSTEM CONTACTS SERVICING

**SYSTEM CALL SETTINGS 1**

**General Call Settings**

Anonymous Call Reject  
 Enable Anonymous Call

**Do Not Disturb**

Enable DND  
Incoming calls: Show

**Call Forward**

Enable Call Forward Always  
Target number:   
 Enable Call Forward Busy  
Target number:   
 Enable Call Forward No Answer  
Target number:   
Delay: 10 rings

Save

## General Call Settings

Setting	Description
Anonymous Call Reject	Select to block incoming calls that have no caller ID.
Enable Anonymous Call	Select to make outgoing calls that remove your own caller ID information.

## Do Not Disturb Settings

Setting	Description	Range	Default
Enable DND	Turns Do Not Disturb on or off.	n/a	Disabled
Incoming Calls	Selects whether the phone displays incoming call information while Do Not Disturb is on.	Show, Reject	Reject

## Call Forward Settings

Setting	Description
Enable Call Forward Always	Select to enable call forwarding for all calls on that account.
Target Number	Enter a number to which all calls will be forwarded.
Enable Call Forward Busy	Select to enable call forwarding for calls when you are on another call on that account.
Target Number	Enter a number to which calls will be forwarded when the line is busy.
Enable Call Forward No Answer	Select to enable call forwarding for unanswered calls on that account.
Target Number	Enter a number to which unanswered calls will be forwarded.
Delay	Select the number of rings before unanswered calls are forwarded. Range: 1 to 10 rings Default: 6 rings

# WebUI

## User Preferences

On the User Preferences page, you can configure some basic settings for your phone and set how your phone responds to calls.

After changing any settings on this page, click **Save** to save them.

	STATUS	SYSTEM	CONTACTS	SERVICING
<b>SYSTEM</b>				
Call Settings				
Account 1				
Account 2				
Account 3				
<b>User Preferences</b>				
Programmable Keys				
Speed Dial				
	<b>General User Settings</b>			
	WebUI Language:		English	▼
	Phone Language:		English	▼
	Backlight Timer (secs):		30	▼
	Ringer Volume:		Off	▼
	Default Audio Mode:		Speaker	▼
	<b>Call Hold Reminder</b>			
	<input checked="" type="checkbox"/> Enable Call Hold Reminder Tone			
	Tone Interval (secs):		60	▼
	<b>Call Waiting</b>			
	<input type="radio"/> Call Waiting Off: Reject Incoming Call if already on a Call			
	<input checked="" type="radio"/> Call Waiting On: View Incoming Call if already on a Call			
	<input type="checkbox"/> Enable Call Waiting Tone			
	Tone Interval (secs):		60	▼
	<input type="button" value="Save"/>			

## General User Settings

Setting	Description	Range	Default
WebUI Language	Sets the language that appears on the WebUI.	Any language supported by your phone. For example, English, French, Spanish, etc.	English
Phone Language	Sets the language that appears on your phone.	Any language supported by your phone. For example, English, French, Spanish, etc.	English
Backlight Timer	Sets how long the screen backlight stays on after the last button press.	10–60 seconds	30 seconds
Ringer Volume	Sets the ringer volume for incoming calls. You can also use the <b>VOLUME ▼</b> or <b>▲</b> keys on the deskset.	Off, 1–9	5
Default Audio Mode	Sets how calls are answered when you press a line key or <b>Answer</b> . See also “Audio” on page 56.	Speaker, Headset	Speaker

# WebUI

## User Preferences (continued)

---

### Call Hold Reminder Settings

Setting	Description	Range	Default
Enable Call Hold Reminder Tone	Enables or disables the call hold reminder tone.	n/a — Select to enable	Enabled
Tone Interval (secs)	Sets the interval for the call hold reminder tone.	10–300 seconds	30 seconds

### Call Waiting Settings

Setting	Description	Range	Default
Call Waiting Off	Rejects additional incoming calls. No notification appears on the screen.	n/a — Select to enable	Disabled
Call Waiting On	Shows additional incoming calls on the screen.	n/a — Select to enable	Enabled
Enable Call Waiting Tone	Enables or disables Call Waiting Tone.	n/a — Select to enable	Enabled
Tone Interval (secs)	Sets the interval for the call waiting tone.	10–60 seconds	30 seconds

# WebUI

## Programmable Keys

The deskset has 12 dual-function programmable keys. You can assign up to 24 functions to the programmable keys on the Programmable Keys page.

Keys can have identical functions, depending on the “Type” of key. For example, you can assign several “Line”-type keys to Account 1 so that you can manage multiple calls on Account 1. You can also assign multiple Quick Dial keys.

For the programmable key default settings, see “Programmable keys” on page 11.

SYSTEM	STATUS	SYSTEM	CONTACTS	SERVICING
<b>SYSTEM</b>	<b>Programmable Keys</b>			
Call Settings	<b>Key</b>	<b>Type</b>	<b>Value</b>	<b>Account</b>
Account 1	Key 1	Line	<input type="text"/>	Account 1
Account 2	Key 2	Line	<input type="text"/>	Account 1
Account 3	Key 3	Line	<input type="text"/>	Account 1
User Preferences	Key 4	Directory	<input type="text"/>	Account 1
<b>Programmable Keys</b>	Key 5	Call History	<input type="text"/>	Account 1
Speed Dial	Key 6	Redial	<input type="text"/>	Account 1
	Key 7	Messages	<input type="text"/>	Account 1
	Key 8	Do Not Disturb	<input type="text"/>	Account 1
	Key 9	Call Forward All	<input type="text"/>	Account 1
	Key 10	N/A	<input type="text"/>	Account 1
	Key 11	N/A	<input type="text"/>	Account 1
	Key 12	N/A	<input type="text"/>	Account 1
	Key 13	N/A	<input type="text"/>	Account 1
	Key 14	N/A	<input type="text"/>	Account 1
	Key 15	N/A	<input type="text"/>	Account 1
	Key 16	N/A	<input type="text"/>	Account 1
	Key 17	N/A	<input type="text"/>	Account 1
	Key 18	N/A	<input type="text"/>	Account 1
	Key 19	N/A	<input type="text"/>	Account 1
	Key 20	N/A	<input type="text"/>	Account 1
	Key 21	N/A	<input type="text"/>	Account 1
	Key 22	N/A	<input type="text"/>	Account 1
	Key 23	N/A	<input type="text"/>	Account 1
	Key 24	N/A	<input type="text"/>	Account 1
	<input type="button" value="Save"/>			

Type	Description
Line	Configures the key for accessing an account. You can make or answer calls by pressing these keys. The key LED will change according to call activity. After selecting <b>Line</b> in the <b>Type</b> column, select the account number in the <b>Account</b> column.



Type	Description
Directory	Configures the key to access the Directory menu. You can then press the key to view the Directory menu.
Call History	Configures the key to access the Call History list. You can then press the key to view the Call History list.
Redial	Configures the key to access the Redial list. You can then press the key to view the Redial list.
Messages	Configures the key to access the Message menu. You can then press the key to view the Message menu.
Do Not Disturb	Configures the key to turn Do Not Disturb on or off. The key is lit orange when DND is on.
Call Forward All	Configures the key to turn Call Forward All on or off. In the <b>Account</b> column, select the account for which Call Forward All will apply. Before assigning the key, ensure that you configure Call Forward settings on the Call Settings page.
Call Forward No Answer	Configures the key to turn Call Forward No Answer on or off. In the <b>Account</b> column, select the account for which Call Forward No Answer will apply. Before assigning the key, ensure that you configure Call Forward settings on the Call Settings page.
Call Forward Busy	Configures the key to turn Call Forward Busy on or off. In the <b>Account</b> column, select the account for which Call Forward Busy will apply. Before assigning the key, ensure that you configure Call Forward settings on the Call Settings page.
Quick Dial	Configures the key to dial a number on the selected line. After selecting Quick Dial, enter the number to be dialed in the <b>Value</b> column. In the <b>Account</b> column, select the account on which the number will be dialed out.
BLF (Busy Lamp Field)	Configures the key to monitor another extension. In the <b>Value</b> column, enter the URI of the extension you want to monitor with this key. For example, 2325552001@sipservice.com.
ACD (Automatic Call Distribution)	Configures the key to display the ACD State menu. In the <b>Account</b> column, select the account that is subscribed to the ACD service.
Page	Configures the key to call one or a group of phones. Pressing the key dials the Paging feature access code. Your System Administrator must configure the feature access code for Paging.
Multicast Page	Configures the key to make outgoing multicast pages. In the <b>Value</b> column, enter a valid Paging Zone ID (ranging from 1 to 10). Multicast paging differs from standard paging in that it is handled locally by the Deskset and does not require a subscription through the hosted server. To use multicast paging, your System Administrator must first set up paging zones on the WebUI.

<b>Type</b>	<b>Description</b>
Park Call	Enables you to park a call. Pressing the key dials the Call Park feature access code (FAC). Your System Administrator must configure the feature access code and any other settings for Call Park.
Retrieve Park Call	Enables you to retrieve a parked call. Pressing the key dials the Parked Call Retrieval feature access code (FAC). Your System Administrator must configure the feature access code and any other settings for Retrieve Park Call.
In Call DTMF	Configures the key to dial a string of numbers while you are on a call. For example, pressing the key might dial a conference access code. After selecting In Call DTMF, enter the number to be dialed in the <b>Value</b> column.
Call Return	Configures the key to dial the number of the last missed call.
Group Call Pickup	Enables you to answer a call ringing at another extension. The call can be ringing at any extension in your phone's call pickup group. Pressing the key dials the Group Call Pickup feature access code (FAC).
Direct Call Pickup	Enables you to answer a call ringing at a specific deskset. Pressing the key dials the Direct Call Pickup feature access code (FAC). Depending on the server requirements, you may then need to enter the number of the ringing extension.

# WebUI

## Directory

To view the local directory, click **CONTACTS** in the WebUI header, and then click **Local directory** in the sidebar.

On the Local Directory page, you can manage your local directory entries. You can sort, edit, delete, and add contact information for up to 200 entries. The page also allows you to export your phone's local directory or import a local directory file. The export function lets you back up your contacts to your computer.

Phone numbers appear as links. If your service provider's **click to dial** feature is enabled, you can dial a number by clicking its link.

The Local Directory lists entries on up to 10 pages, with 20 entries per page. Click **Next**, **First**, **Last**, or a page number to view the desired page of entries.

**Note:** You can also use the phone menu to manage your local directory entries. For more information, see "Using the local directory" on page 40.

**CONTACTS**

Local Directory  
Blacklist  
Call History

**STATUS**      **SYSTEM**      **CONTACTS**      **SERVICING**

**Local Directory**

Select All       [Sort By Last Name](#)

Total: 21	First Name	Last Name	Ringer Tone	Work	Mobile	Other	Account	
<input type="checkbox"/>	Angela	Martin	0	<a href="#">7325550118</a>			1	<a href="#">Edit</a>
<input type="checkbox"/>	Bronwyn	McDonald	0	<a href="#">2325550140</a>			1	<a href="#">Edit</a>
<input type="checkbox"/>	Charlie	Johnson	0	<a href="#">5550198</a>			1	<a href="#">Edit</a>
<input type="checkbox"/>	Dale	Appleton	0		<a href="#">6045550135</a>		1	<a href="#">Edit</a>
<input type="checkbox"/>	David	Carter	3	<a href="#">2325550194</a>	<a href="#">2325550177</a>		2	<a href="#">Edit</a>
<input type="checkbox"/>	Davis	Swerdlow	0		<a href="#">2325550172</a>		1	<a href="#">Edit</a>
<input type="checkbox"/>	Elkhart	Taxi	0		<a href="#">6045550155</a>		1	<a href="#">Edit</a>
<input type="checkbox"/>	Graham	Ball	0		<a href="#">2325550176</a>		1	<a href="#">Edit</a>
<input type="checkbox"/>	Kathryn	Dolphy	0		<a href="#">6045550195</a>		1	<a href="#">Edit</a>
<input type="checkbox"/>	Linda	Miller	0		<a href="#">6045550117</a>		2	<a href="#">Edit</a>
<input type="checkbox"/>	Lydia	Braithwaite	0	<a href="#">2325550157</a>			1	<a href="#">Edit</a>
<input type="checkbox"/>	Martin	Meyers	0	<a href="#">2325550122</a>			1	<a href="#">Edit</a>
<input type="checkbox"/>	Mary	Williams	0		<a href="#">6045550145</a>	<a href="#">6045550146</a>	1	<a href="#">Edit</a>
<input type="checkbox"/>	Richard	Serling	0		<a href="#">6045550141</a>	<a href="#">7875550181</a>	2	<a href="#">Edit</a>
<input type="checkbox"/>	Robert	Brown	2		<a href="#">6045550105</a>		2	<a href="#">Edit</a>
<input type="checkbox"/>	Sandro	Voss	0	<a href="#">2325550149</a>			1	<a href="#">Edit</a>
<input type="checkbox"/>	Stefan	Wheeler	0		<a href="#">2325550161</a>		1	<a href="#">Edit</a>
<input type="checkbox"/>	Susan	Ballance	0		<a href="#">6045550170</a>		1	<a href="#">Edit</a>
<input type="checkbox"/>	Terry	Ng	0		<a href="#">2325550187</a>		1	<a href="#">Edit</a>
<input type="checkbox"/>	Ursula	Baldwin	0	<a href="#">6045550165</a>			1	<a href="#">Edit</a>

**First** 1 [Last](#) [Next](#)

[Delete Selected Entries](#)      [Add New Entry](#)      [Clear Directory](#)

**Import Local Directory**

No File Chosen      [Choose File](#)

[Import](#)

**Export Local Directory**

[Export](#)

## Local Directory

Click	To...
<a href="#">Sort By Last Name</a>	Sort the list by last name.
<a href="#">Edit</a>	Edit information for an entry.
<a href="#">Last</a>	View the last page of entries.
<a href="#">Next</a>	View the next page of entries.
<a href="#">Delete Selected Entries</a>	Delete selected entries from the directory. Click <b>Select All</b> to select every entry on the page you are viewing.
<a href="#">Add New Entry</a>	Add a new directory entry.
<a href="#">Clear Directory</a>	Delete all Directory entries

### To add a new directory entry:

1. Click **Add New Entry**.

The **Create Local Directory Entry** page appears.

2. Enter the required information. At minimum, a first and last name are required.

Setting	Description	Range	Default
First Name	Enter the appropriate names in these fields.	n/a	n/a
Last Name			
Ringer Tone	Sets a unique ringer tone for calls from this directory entry.	Auto, Tone 1–10	Auto
Account	Sets the account used when you dial this directory entry.	Default Account, Account 1–Account 3	Default Account
Work Number	Enter the appropriate numbers in these fields.	n/a	n/a
Mobile Number			
Other Number			

3. Click **Save**.

# WebUI

## To edit a directory entry:

1. Click Edit for the entry you want to edit.

The **Edit Local Directory Entry** page appears.

The screenshot shows the 'Edit Local Directory Entry' page. On the left is a blue sidebar with 'CONTACTS' and 'Local Directory' highlighted. The main area has a dark header with 'STATUS', 'SYSTEM', 'CONTACTS', and 'SERVICING'. Below the header, the title 'Edit Local Directory Entry' is followed by a form with the following fields: First Name: John, Last Name: Smith, Ringer Tone: Auto (dropdown), Account: Default Account (dropdown), Work Number: 5551231234, Mobile Number: 5558729863, and Other Number: 5556126549. A blue 'Save' button is at the bottom.

2. Edit or add the desired information.
3. Click **Save**.

## Import Local Directory

You can import an existing local directory file. Importing a directory file replaces all your previous local directory entries. After importing a directory file, you can add, edit, or delete entries as desired.

**Note:** Directory files are .xml files containing contacts and contact information. For more information about creating or editing a directory file, consult your system administrator.

## To import a local directory file:

1. Click **Choose File**.
2. In the **Choose File to Upload** window, navigate to the directory file.
3. Click the file, and then click **Open**.
4. On the WebUI, click **Import**.

## Export Local Directory

You can export the directory and save it as an .xml file on your computer.

## To export the local directory:

1. Click **Export**.
2. At your browser's prompt, save the file to the desired location on your computer.

# WebUI

## Speed Dial

The speed dial keys are used for dialing numbers with one key press. To view the speed dial keys, click **SYSTEM** in the WebUI header, and then click **Speed Dial** in the sidebar.

On the Speed Dial page, you can enter up to 10 numbers that you dial frequently. To dial a speed dial number, press and hold the dial pad key that matches the speed dial entry number (for entry 10, press 0). For each speed dial number you enter, you must assign the account on which the number will be dialed out.

You can also add speed dial entries using the deskset. The Speed dial list is accessed through the Features menu. See “Speed Dial” on page 46.

After entering information on this page, click **Save** to save it.

**Note:** Your system administrator can also assign programmable function keys to be quick dial keys, but you cannot add or edit phone numbers for these keys. Use the Speed Dial page to enter numbers that you personally want to dial often.

Key	Name	Value	Account
Key 1	<input type="text"/>	<input type="text"/>	Default ▾
Key 2	<input type="text"/>	<input type="text"/>	Default ▾
Key 3	<input type="text"/>	<input type="text"/>	Default ▾
Key 4	<input type="text"/>	<input type="text"/>	Default ▾
Key 5	<input type="text"/>	<input type="text"/>	Default ▾
Key 6	<input type="text"/>	<input type="text"/>	Default ▾
Key 7	<input type="text"/>	<input type="text"/>	Default ▾
Key 8	<input type="text"/>	<input type="text"/>	Default ▾
Key 9	<input type="text"/>	<input type="text"/>	Default ▾
Key 0	<input type="text"/>	<input type="text"/>	Default ▾

### To enter speed dial numbers:

1. In the **Name** column, enter a speed dial label for the desired key.
2. In the **Value** column, enter a phone number for the desired key.
3. In the **Account** column, select the account that this speed dial number will use.
4. Click **Save**.

# Troubleshooting

If you have difficulty with your telephone, please try the suggestions below. For customer service, visit our website at **businessphones.vtech.com** or call **1 (888) 370-2006**.

## General issues

---

### Screen is blank.

- Ensure power is connected. If powered by an AC adapter, check that adapter is plugged into a wall socket and the Deskset power jack. If powered by PoE, ensure that the network switch is providing power through the correct ports.

### The DECT headset doesn't register. "Registration failed" appears on the screen.

- Deregister the headset from the deskset to which it had been registered.
- Remove and replace the headset in its charger before pressing **Register** on the deskset.

### Intercom calls (Pages) are not received.

- Your phone can be configured to answer intercom calls (pages) automatically. See your system administrator if your phone doesn't answer intercom calls automatically.

### Calls are answered on the headset rather than the speakerphone after I press a Line key or Answer to answer a call.

- Change the audio mode from Headset to Speaker. See "To set the audio mode:" on page 57.

### Incoming calls do not ring on the deskset when using a cordless handset.

- If you are on a call using the handset, then additional incoming calls will emit a call waiting tone on the handset, but the deskset ringer will be silent.

### My computer can't connect to the network after plugging the Ethernet cable through the PC port.

- Make sure the deskset is connected to power. The PC port does not work when the deskset does not have power source or during a power outage.
- Make sure you plug the Ethernet cable connected to the router into the deskset Ethernet port and the Ethernet cable connected to the computer into the deskset PC port.

### The network connection speed on my computer drops significantly after plugging the Ethernet cable through the PC port.

- If you are using a Gigabit Ethernet system, the connection speed drops to 100 Mbps after plugging the Ethernet cable through the PC port.

## My caller ID isn't working.

- Caller ID is a subscription service. Your telephone service provider may require subscription to this service for this feature to work.
- The caller must be calling from an area that supports caller ID.
- Both your telephone service provider and your caller's service provider must use caller ID compatible equipment.

## Specifications

### Electrical and environmental specifications

---

RF frequency band	1921.536–1928.448 MHz
Channels	5
Operating temperature	32–122 °F (0–50 °C)
AC adapter output voltage	5.0 Vdc @ 1000 mA
Ethernet network jacks	10/100 Mbps RJ-45 Jacks



# Soft Keys

## Index of soft keys

---

The table below provides an alphabetical list of the labels that appear above the deskset soft keys.

<b>Label</b>	<b>Description</b>
abc/ABC/123	Selects the text format for input
Add	Enters a new directory group editor
Add dot	Enters dot in IP editing field
Answer	Answers an incoming call
Back	Shows the previous screen
Backspc	Moves cursor back to correct entries in text editing fields
Blind	Starts the blind transfer process for the active call
Bridge	Joins the two active calls in a conference and returns to idle screen
Callback	Dials the last missed caller
Cancel	Quits the current screen without saving any settings
Conf.	Opens the live dialing editor to enter digits for the conference target
ConfCall	Displays a list of held calls as a target for conferencing with the active call
Del. All	Deletes all records in a list
Delete	1) Deletes current entry 2) Deletes assignment 3) Deletes Directory group
Dial	Sends and dials currently displayed/highlighted digits
Directory	Opens the list of available directories
Edit	Displays the entry/group editor
EditDial	Edits a number stored in a list before dialing
End	1) Closes the current page 2) Ends the current call
Exit	Exits the current screen and returns to the previous menu
FirstNme	Sorts the directory by first name
Forward	Opens the predial editor to begin forwarding a call
Insert	Inserts a number from the directory or call history to a live dialing screen
LastNme	Sorts the directory by last name
Line	Switches between registered lines
New	Press to predial a new call during a call currently put on hold
No	Returns to the previous screen
Reject	Rejects an incoming call

# Soft Keys

## Index of soft keys (continued)

---

Label	Description
Resume	Resumes a call put on hold
Save	1) Saves current setting 2) Begins save process
Search	Opens the Directory search editor
Select	Selects a highlighted option
Settings	Opens the User settings menu
Conf	Confirms to set up conference
Transf	Confirms to transfer call
Split	Breaks a conference or call progress into multiple calls
Status	Access the status submenu
Transfer	Opens the live dialing editor to enter or insert digits of the transfer target
Type	Switches between the Directory number types within an entry
View	Displays a database/list
XferCall	Displays a list of held calls as a transfer target for the active call
Yes	Confirm

# Special Characters

## Entering special characters

---

When entering text using the dial pad, the following special characters are available. Press the 1, star (✖), 0, or pound sign (#) keys to enter special characters.

Key	Characters
1	~ ^ ` % ! & - _ + =
✖	. @ *
0	: ; “ , ?
#	( ) [ ] { } < > / \ #

# Maintenance

## Taking care of your telephone

---

- Your telephone contains sophisticated electronic parts, so you must treat it with care.
- Avoid rough treatment.
- Place the corded handset down gently.
- Save the original packing materials to protect your telephone base if you ever need to ship it.

### Avoid water

- You can damage your telephone if it gets wet. Do not use the corded handset in the rain, or handle it with wet hands. Do not install the telephone near a sink, bathtub or shower.

### Electrical storms

- Electrical storms can sometimes cause power surges harmful to electronic equipment. For your own safety, take caution when using electric appliances during storms.

### Cleaning your telephone

- Your telephone has a durable plastic casing that should retain its luster for many years. Clean it only with a soft cloth slightly dampened with water or a mild soap.
- Do not use excess water or cleaning solvents of any kind.

Remember that electrical appliances can cause serious injury if used when you are wet or standing in water. If the telephone should fall into water, **DO NOT RETRIEVE IT UNTIL YOU UNPLUG THE POWER CORD AND NETWORK CABLE FROM THE WALL**, then pull the unit out by the unplugged cords.

# GPL License Information

## GPL code requests

---

Portions of the software associated with this product are open source, and fall within the scope of the GNU General Public License (GPL). Accordingly, those portions of code are available to the public, consistent with the requirements of the GPL, in either source code format or object code format, depending upon the nature of the code at issue. If you would like to exercise your right to receive the available code, please send a written request for the available code along with a cashier's check, payable to VTech Communications, Inc., in the amount of \$15.00 (U.S.\$) to:

VTech Communications, Inc.,  
9590 SW Gemini Drive, Suite 120  
Beaverton OR 97008

ATTN: Information Technology Group—VSP725 GPL code request

If your request does not fully comply with the foregoing requirements, VTech reserves the right to reject your request. Further, by requesting and receiving the available code, you release VTech, its affiliates, and its and their officers, directors, employees, and representatives ("VTech Parties") from any liability or responsibility relating to such code, and you acknowledge that the VTech Parties make no representations with respect to the origin, accuracy, usability, or usefulness of such code, and the VTech Parties have no responsibility to you whatsoever concerning the code, including without limitation any responsibility to provide explanation, support, upgrade, or any communication whatsoever. Your review or use of the available code is at your sole risk and responsibility.

VTECH COMMUNICATIONS LTD.

A member of THE VTECH GROUP OF COMPANIES.

Distributed in the U.S.A. by VTech Communications Inc., Beaverton, Oregon 97008.

VTech is a registered trademark of VTech Holdings Limited.

ErisTerminal® is a registered trademark of VTech Communications Inc.

Specifications are subject to change without notice.

Copyright © 2014–16 for VTECH COMMUNICATIONS LTD. All rights reserved.

Version 6, 06/16